

Metso:Outotec

Chute solutions

Working together for you

Handbook version 1.1



Chute solutions – working together for you

Metso Outotec relies on a global pool of about 15,000 dedicated employees to help our customers achieve results in every part of their operation.

Metso Outotec chute lining solutions reflect that commitment in every product and service we offer. Working closely with our customers, we go beyond simply being a liner supplier to tailoring solutions that help maximize productivity and profit for our customers. We make every effort to understand the customer's business at every level and become a true partner in helping them achieve all that is possible at every production site, wherever it is and whatever the challenges.





Contents

Your partner for maximum productivity	4
Lining systems overview	9
Metallic wear lining	11
Xledge	15
Cast liner products	21
Metal Matrix composites	31
Atomx	32
Xalloy	33
Xblock	41
Rubber wear lining	53
Trellex PP	61
Trellex PT	69
Trellex SB	71
Trellex SP	75
Trellex WB	81
Trellex Flexback	83
Trellex SQ 300	87
Microledge	91
PU wear lining	95
Ceramic wear lining	105
Sheetings and coatings	125
Attachment systems	141
Handling systems	169
Wear monitoring systems	177
Value added services	183
Application examples	187



Your partner for maximum productivity

Working with Metso Outotec represents a flexible and reliable partnership towards maximizing productivity. It goes beyond the production, supply and stocking of products. We advise on the best possible configuration and choice of liners to ensure that the wear lining solution maximizes production and minimizes downtime while being as sustainable as possible.

Partnering with Metso Outotec means having more options from the widest range of dependable wear lining solutions from a single source and the peace of mind of continuous support from a partner whose definition of success is how well we contribute to yours.

Reaching your targets

Our customers strive to increase uptime, maximize throughput, reduce costs and improve safety while also managing sustainable business operations. This can be challenging from a wear protection aspect, and frequent maintenance is required in sometimes risky working conditions. Protecting the equipment with the correct wear material and attachment system can help overcome those issues.

We help you achieve your strategic objectives by finding solutions that increase the efficiency of your operation.



How do our solutions improve safety?

- Increased uptime means fewer hours of risky maintenance
- Light-weight products and easy change-outs mean safer and shorter maintenance stops
- Minimized manual handling
- Fewer hot work situations and less exposure to confined spaces

How do our solutions maximize throughput?

- Long-lasting and reliable solutions keep materials flowing
- Optimized change-outs means more production

How do our solutions increase uptime?

- Long wear life means fewer stops
- Faster installations using our tools, fasteners and installation methods
- Liner design optimized for quick installation and removal

How do our solutions reduce costs?

- Reduced downtime
- Improved wear material utilization
- Lower operational cost per ton

How do our solutions improve sustainability?

- Only change liners that need to be changed
- Recycle liner material, where possible
- Reduce wastage through better material utilization

The next level of performance

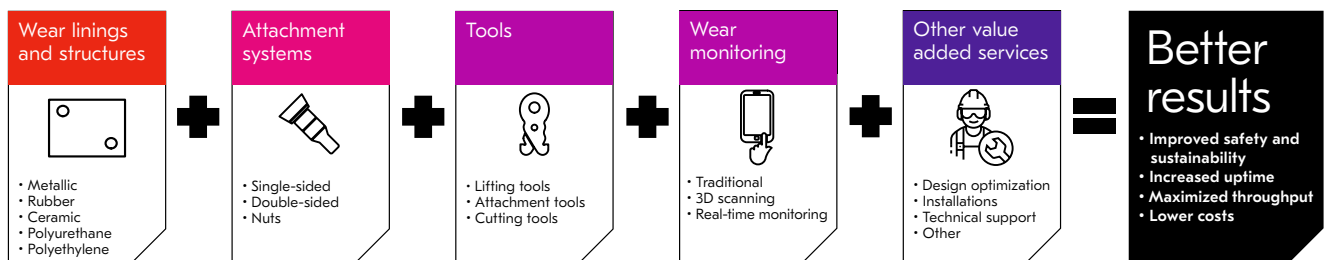

By working closely together and by combining the knowledge you have of your process with our optimized wear liners and unique services and tools, we can take your wear protection to the next level.

Metso Outotec process of optimization

Your process changes and we change along with it. Change is the only constant. For us, continuous optimization means working closely with you to truly understand your process and improve it accordingly.

The process of optimization is at the heart of how we do business and operate. Not only do we perform a thorough **audit** and **review** of your operation, we also carefully simulate and compare different options to ensure the solution selected is the right one.

Excellent results can often be achieved by combining materials – such as metals, rubber, polyurethane and ceramics – and taking full advantage of the best features of each.

Our products are **produced** using state-of-the-art technology and efficiently installed using safe tools and methods. And when the parts are in operation, we **monitor** closely and make improvements if needed. This way we get better each time, making it possible for you to maximize plant efficiency, minimize downtime and ensure measurable cost savings.

With Metso Outotec, you don't just get wear parts, you get continuous performance **improvement**.

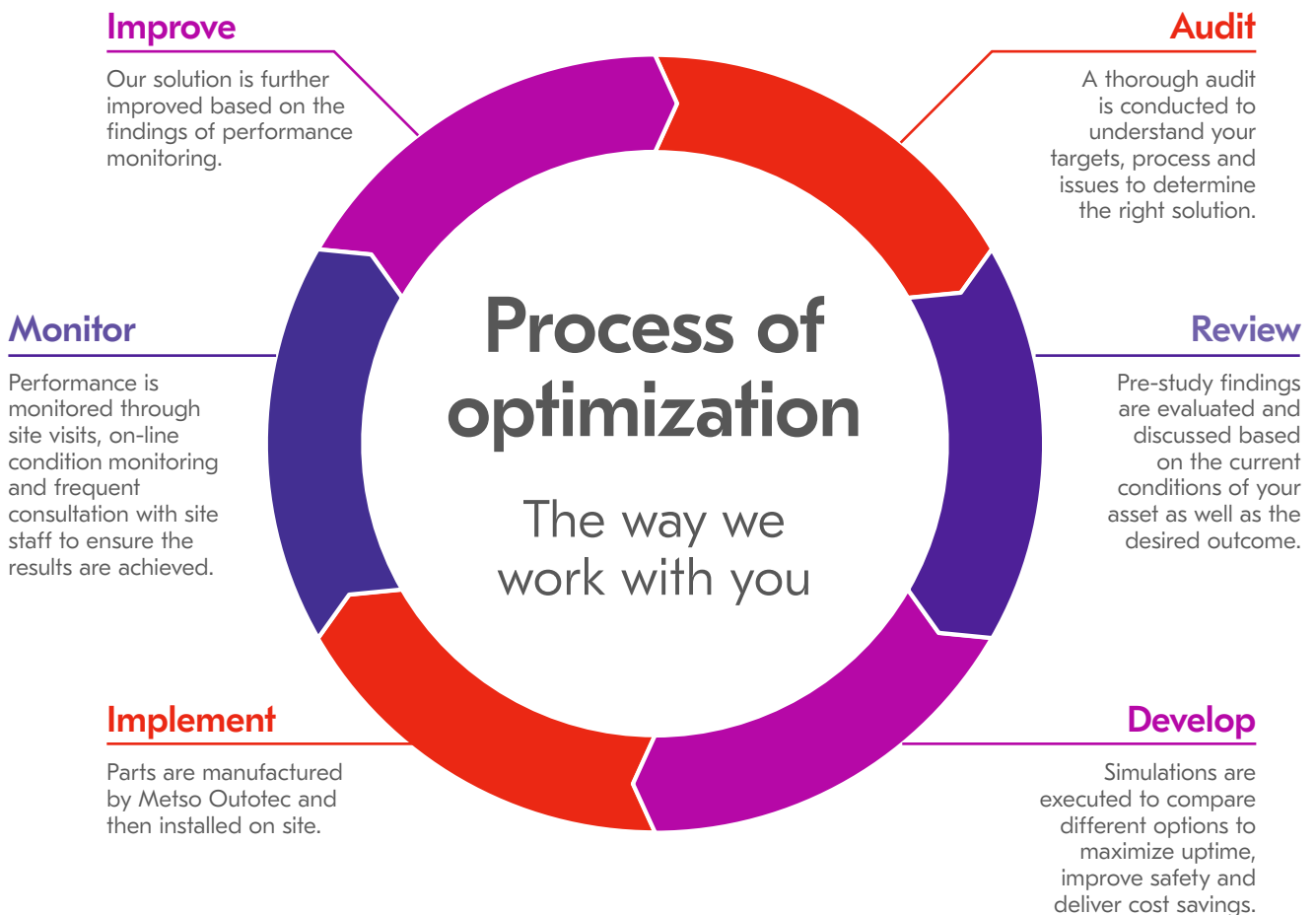

Lining systems overview



Lining system - selection guide

Choosing the right lining solutions can be complicated. There are always numerous considerations that help identify the most appropriate lining product and lining material grade that will provide the optimum protection for your assets.

The table below provides a broad perspective on the potential combinations of available wear lining products and materials that can be used in their construction.

Product description (name)	Product lining material												
	High chrome white iron	NiHard	Manganese steel	High alloy steel	XO weld overlay plate	FO fused overlay plate	AR abrasion-resistant plate	Xblock bimetallic	Metal matrix composite	Rubber	Ceramic	Polyurethane	Polyethylene
Wear liner/lining elements	●	●	●	●	●	●	●	●	●	●	●	●	●
Gridlock	●	●	●	●	●	●	●						
Rockbox	●	●		●									
Xledge	●								●		●		
Xlok	●				●	●	●			●	●		
Atomx	●												
SQ300										●	●	●	
Microledge										●			

Find out more about each of these products in the different product sections of this handbook.

When it comes to searching for a lining system for asset protection, many factors must be considered, including but not limited to abrasive wear, impact resistance, material flow and chemical resistance.

Generally speaking, one of the key determining factors of abrasive wear resistance for lining materials is their hardness properties. In most cases, a higher hardness material will offer better abrasive wear performance than a lower hardness material; however, this can come at the expense of impact toughness, since higher hardness also often results in less ductility. Therefore, it is critical to correctly assess the needs of the lining application to identify the best combination of these properties. The below table provides a general comparison of material hardness values for a range of common wear lining materials. Material hardness can often be used as a guide for determining abrasive resistance.

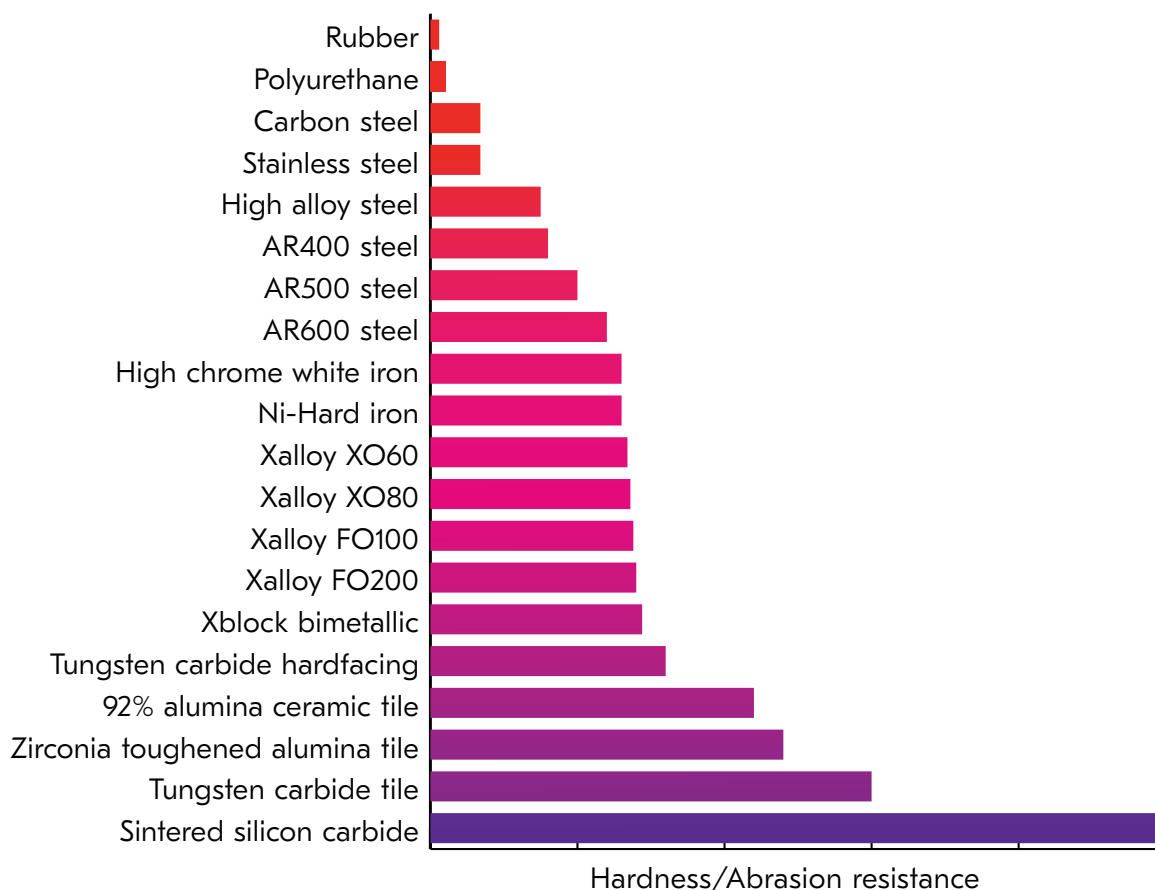

For metallic lining materials, material hardness and the inherent relationship with ductility and impact toughness are often the key determining factors for selection. This must then be incorporated into the lining design for maximum benefit. Learn more about the features of the Metso Outotec metallic lining range in the chapters that follow.

When considering non-metallic materials for lining solutions, the Trellex product range stands alone, considering three key selection factors: wear improvement, flow improvement, and noise reduction. Learn more about these characteristics and the Trellex product range in the following chapters.

Metallic wear lining

Metallic wear lining

The Metso Outotec range of metallic chute lining solutions provides an appropriate product for any application and complements the already extensive range of Trelex non-metallic lining solutions.



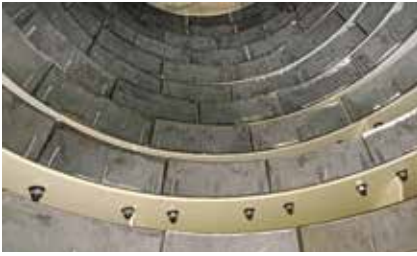

Wearback™

Utilizing a rock-on-rock design, the custom-built Wearback chutes take advantage of the build-up of material to significantly prolong wear life compared to a conventional chute lining.



Xledge™

Specialized range of ledge liners used on Wearback™ chutes to protect the parent metal. Consists of few parts and easy-to-handle small liners. The low-weight lining provides excellent abrasion and impact resistance.



Gridlock™

Anti-wash liner system designed to eliminate joint wash generated by using square liners. Available in horizontal, vertical and double-sided designs in a wide range of sizes and materials.



Rockbox

The liner design effectively captures fine material that acts as a protective layer. Rock-on-rock wear results in very little wear on the lining itself.



Xalloy™

Xalloy wear linings comprise a range of abrasion-resistant steel and bimetallic sheeting solutions, solutions that offer resistance to extreme abrasion and to some impact.



Xblock

A wide range of bimetallic wear parts comprising a high hardness chromium molybdenum alloyed cast iron wear element that has been metallurgically bonded to a weldable steel backing plate.



Cast liners

Cast liners can be manufactured in a range of alloys designed to suit the intended application. From high hardness white irons offering high abrasion resistance to manganese steels offering impact toughness, there is metallic cast liner product to suit any application.

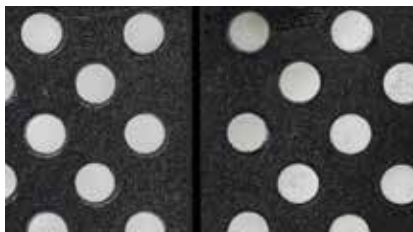

Metal matrix composites

Metal matrix composite wear liners provide an innovative ultra-wear-resistant material by combining the very high hardness materials imbedded within high hardness chrome cast iron matrices. The composite design provides the combined benefits for lower cost-per-ton of material processed.



Atomx

The Atomx wear liner developed by Metso Outotec is a hybrid design liner using cast wear-resistant element(s) bonded to a steel backing plate using rubber vulcanization. The hybrid design provides a combination of impact and abrasive wear resistance.



Xledge™



Xledge™ liners for Wearback™ chutes

Xledge liner systems are a patented feature of Metso Outotec Wearback chutes and can also be installed to existing chutes. The engineered design allows material to build up throughout the transfer, promoting rock on rock impact and wear while minimizing liner wear and promoting flow of material through the transfer chute. Xledge liners are easily handled, each weighing significantly less than conventional chute lining parts, and can be configured to fully line a chute using as few as 5 different size parts, minimizing the number of line items for inventory management.



A range of existing reference installation arrangements is available to suit various transfer chute heights and ledge radiuses.

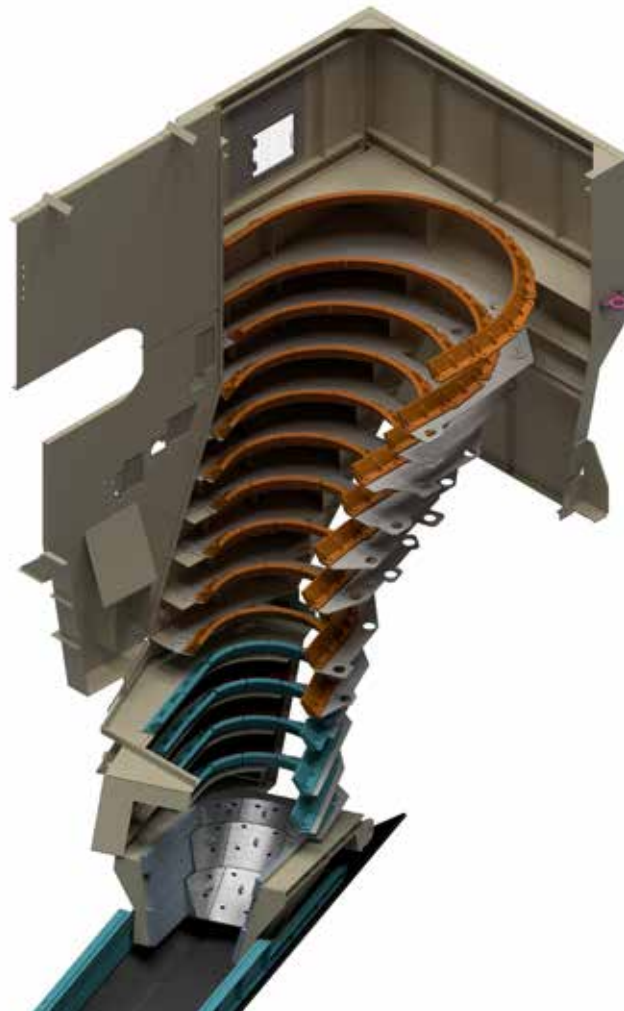



A lighter but stronger and safer solution

Xledge wear liners come in a range of different sizes and shapes – all weighing significantly less than traditional liner parts, which can weigh as much as 50 kg each. The lighter weight makes handling both safer and easier, and inventory management gets simpler with a minimized number of Xledge liners.

The Wearback design allows ore to build up behind the Xledge liners to mostly bury the liner, only exposing the top face to wear. This is a significant benefit compared to a square billet, where the entire top face can be exposed.

Replacing poor performing transfer chutes

Many rockbox style chutes have been installed across the globe. Xledge liners can be retro-fitted to these to provide measurable improvements. A labor saving of up to 70% can be achieved, as the Xledge liners are quicker and easier to change. An Australian case study showed an annual total cost reduction of 80% (parts and labor).

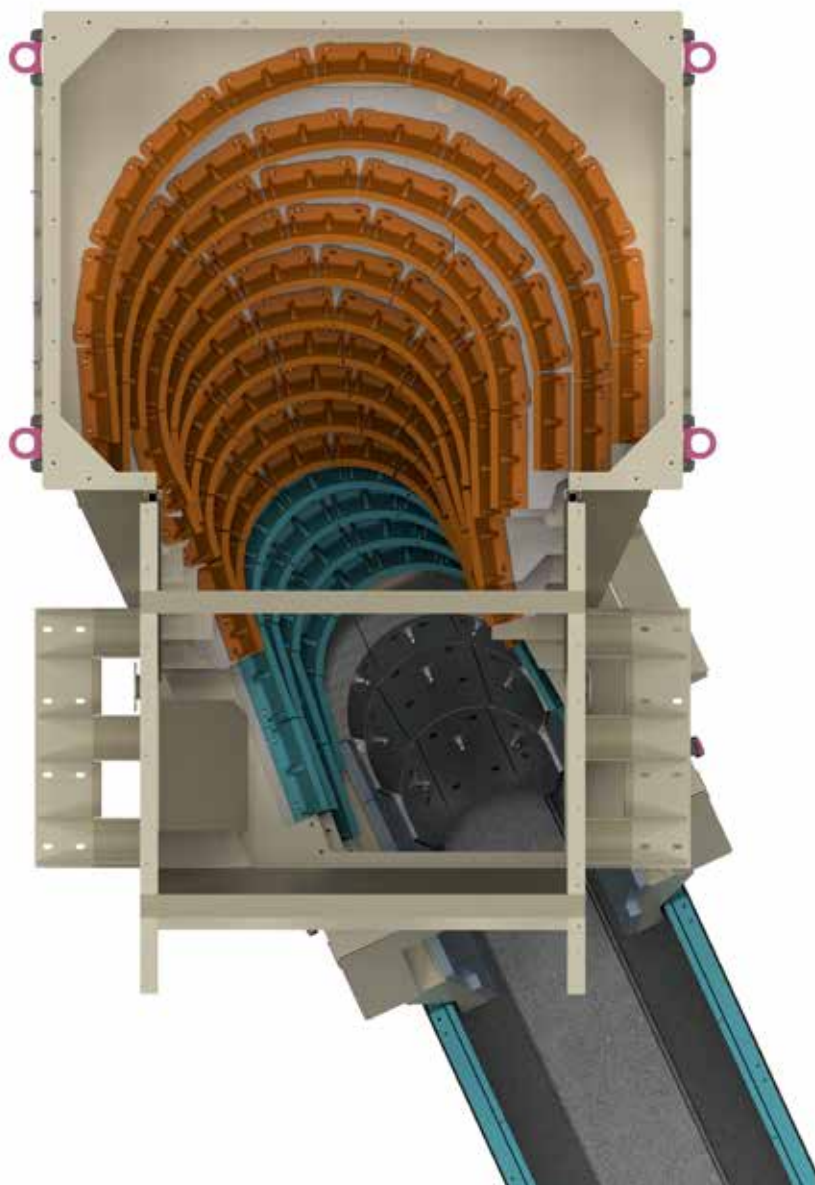

Technical description

There are three separate ranges or styles of Xledge liner parts, each containing six basic design types, which are utilized in combination to complete an optimized lining package. The height of an Xledge liner is selected to suit the requirements of each application and shelf spacing limitations.



Xledge heavy duty (100 mm high)		
Part no.	Description	Mass (kg)
ZX11713088	Xledge HD100 Type 1	10.00
ZX11713090	Xledge HD100 Type 2	15.04
ZX11713092	Xledge HD100 Type 3	17.34
ZX11713095	Xledge HD100 Type 4	20.27
ZX11713099	Xledge HD100 Type 5	20.03
ZX11713101	Xledge HD100 Type 6	10.12

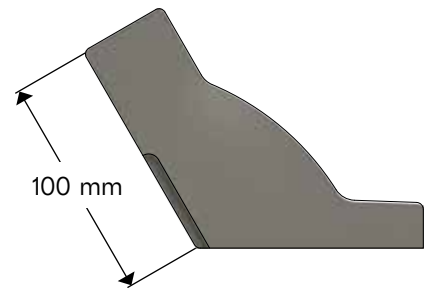

Xledge heavy duty (140 mm high)		
Part no.	Description	Mass (kg)
ZX11710737	Xledge HD140 Type 1	12.51
ZX11712812	Xledge HD140 Type 2	19.34
ZX11710734	Xledge HD140 Type 3	21.75
ZX11712814	Xledge HD140 Type 4	26.17
ZX11712816	Xledge HD140 Type 5	26.53
ZX11708098	Xledge HD140 Type 6	13.70

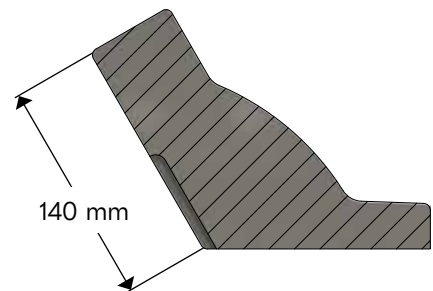

Xledge heavy duty (160 mm high)		
Part no.	Description	Mass (kg)
ZX11803292	Xledge HD160 Type 1	15.02
ZX11800024	Xledge HD160 Type 2	23.64
ZX11803293	Xledge HD160 Type 3	26.16
ZX11803294	Xledge HD160 Type 4	32.07
ZX11800027	Xledge HD160 Type 5	33.03
ZX11800039	Xledge HD160 Type 6	17.28

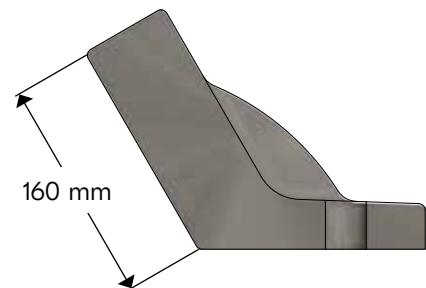

Cast liner products



Cast liner products

The Metso Outotec cast liner range provides a diverse selection of standard and customized design liner products that can be manufactured in a range of alloys to suit the intended application. From high hardness white irons offering high abrasion resistance to manganese steels offering impact toughness, there is metallic cast liner product to suit any application.

- Metallic cast alloys tailored for each solution
- Unique combination of abrasive wear resistance and impact resistance
- A wide range of standard liner parts and modular designs
- Customized liner layout designs also a specialty

Choice of materials:

Ni-hard white iron

Typically supplied as Ni-hard 4 grade, Ni-hard white iron is alloyed primarily with chromium and nickel to produce castings with properties displaying an excellent combination of abrasion wear resistance and impact toughness.

High chrome white iron

A range of proprietary alloy grades, based on international standard grades, highly alloyed primarily with chromium, and heat treated to achieve properties offering excellent sliding abrasion resistance while also presenting moderate impact resistance when used in the appropriate application.

High alloy steel

The Metso Outotec alloy steel liner range features steel castings with an excellent combination of wear resistance and moderate to high impact resistance capabilities.

Manganese steel

The Metso Outotec manganese steel range provides austenitic manganese steel castings with excellent impact resistance and work hardening capabilities. There are various grades that can be selected to suit the application.

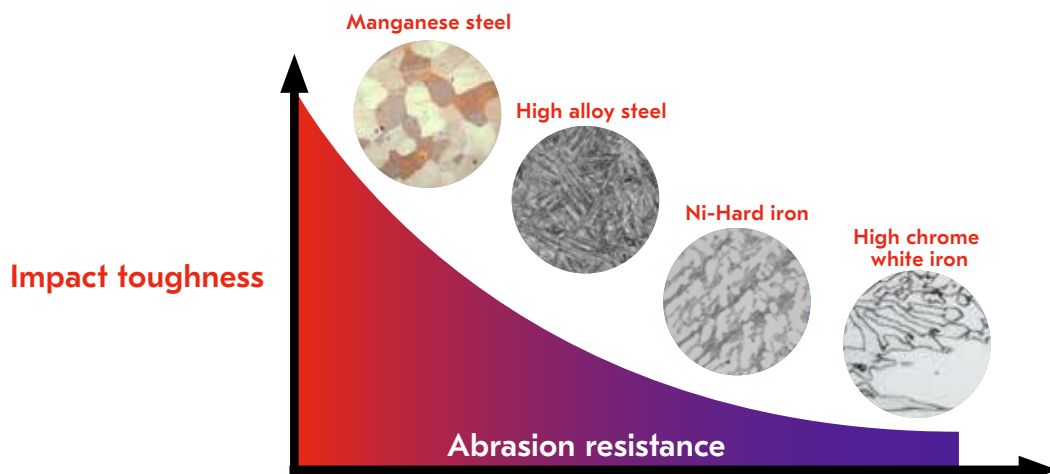

Cast liner product range

Standard Ni-Hard cast liner parts

A range of industry standard sized wear liner plates and billets. Customized and specific parts can also be engineered, including material grade modifications and bolt hole configurations.

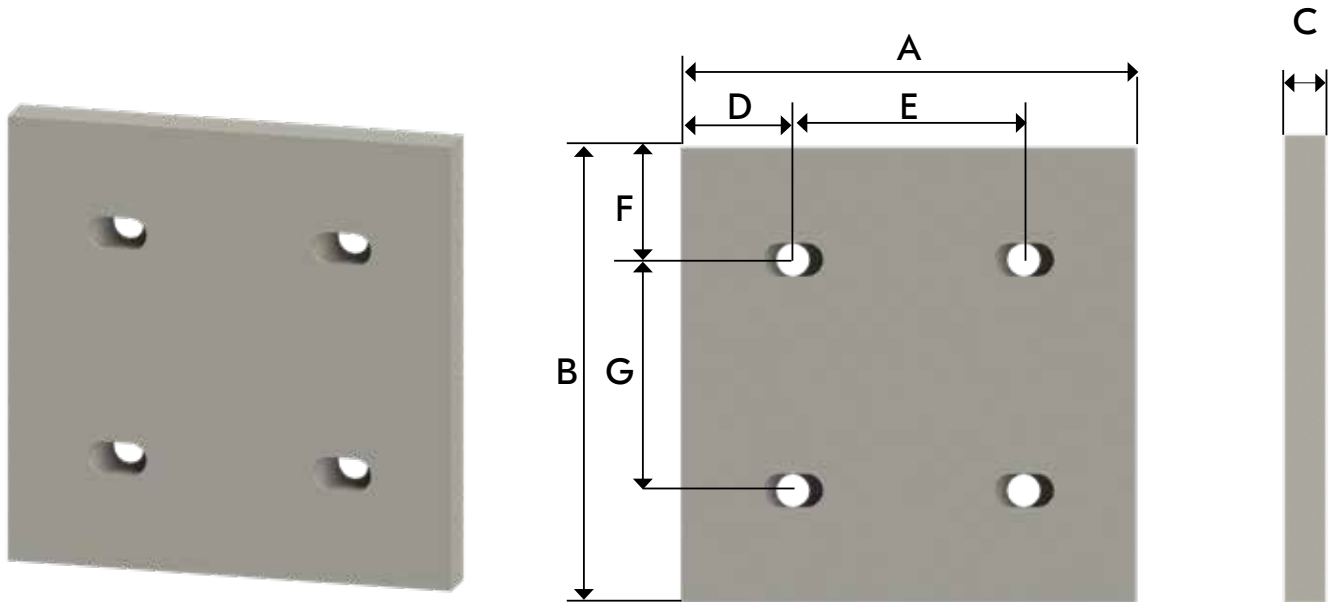

Standard Ni-Hard cast liner parts									
Part no.	Description	Dimensions (mm)							Mass (kg)
		A	B	C	D	E	F	G	
Standard liners – M16 fasteners									
ZX11902060	CP 300 x 300 x 25 M16	300	300	25	74	153	150	-	17
ZX11902061	CP 300 x 150 x 25 M16	300	150	25	74	153	75	-	9
ZX11927322	CP 300 x 300 x 32 M16	300	300	32	74	153	150	-	21
ZX11927324	CP 300 x 150 x 32 M16	300	150	32	74	153	75	-	11
ZX11927325	CP 300 x 300 x 40 M16	300	300	40	74	153	150	-	28
ZX11927326	CP 300 x 150 x 40 M16	300	150	40	74	153	75	-	14
ZX11927327	CP 300 x 300 x 50 M16	300	300	50	74	153	150	-	35
ZX11927328	CP 300 x 150 x 50 M16	300	150	50	74	153	75	-	17

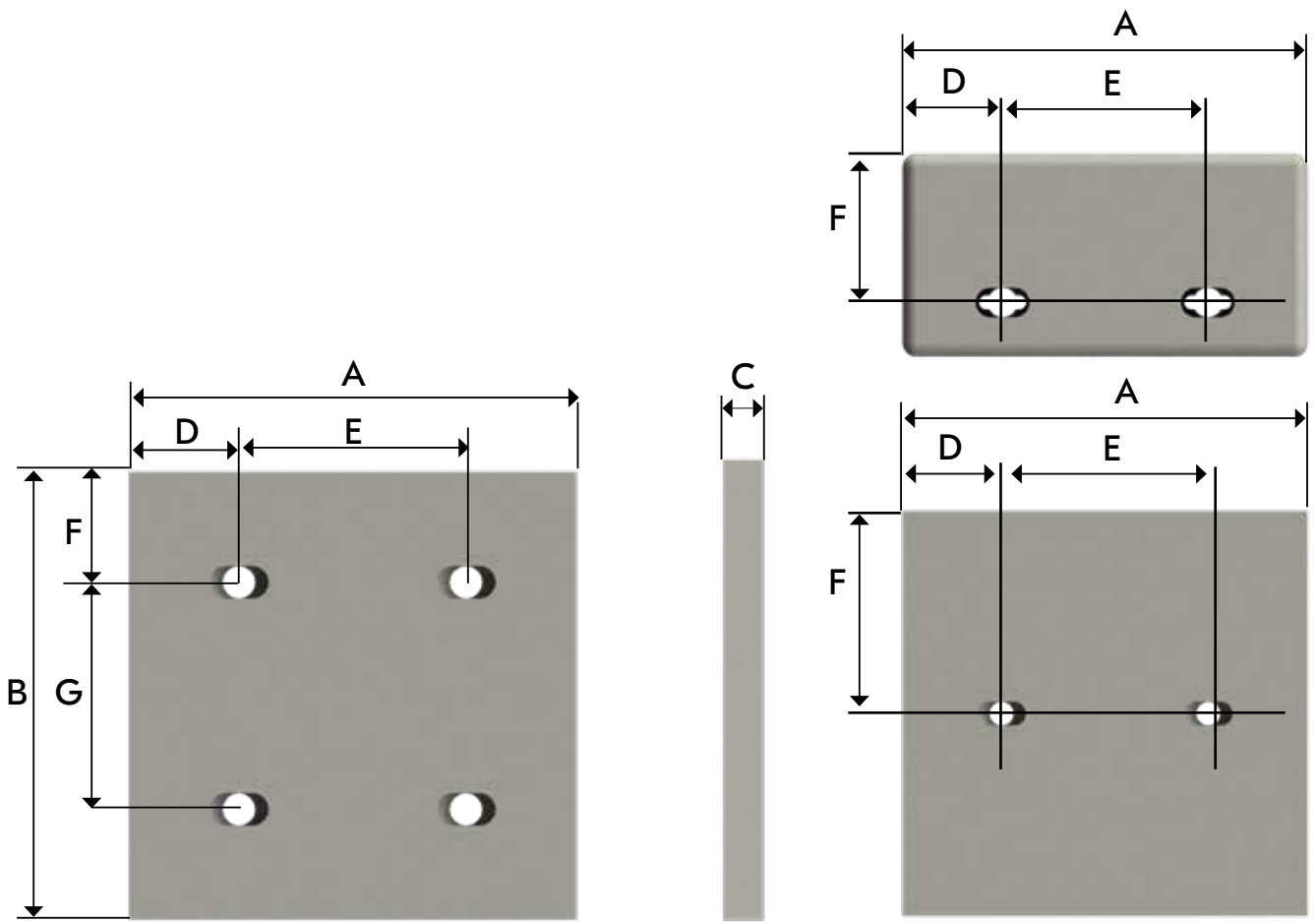

Standard Ni-Hard cast liner parts

Part no.	Description	Dimensions (mm)							Mass (kg)
		A	B	C	D	E	F	G	
Standard liners – M20 fasteners									
ZX11902062	CP 300 x 300 x 32 M20	300	300	32	74	153	74	153	21
ZX11902063	CP 300 x 150 x 32 M20	300	150	32	74	153	75	-	11
ZX11927329	CP 300 x 300 x 40 M20	300	300	40	74	153	74	153	28
ZX11927330	CP 300 x 150 x 40 M20	300	150	40	74	153	75	-	14
ZX11927331	CP 300 x 300 x 50 M20	300	300	50	74	153	74	153	35
ZX11927332	CP 300 x 150 x 50 M20	300	150	50	74	153	75	-	17
Billets – M20 fasteners									
ZX11902058	CB 300 x 150 x 100 M20	300	150	100	74	152	40	-	33
ZX11902059	CB 224 x 150 x 100 M20	224	150	100	36	152	40	-	25

Cast liner product range

Standard high chrome white iron cast liner parts

A range of industry standard sized wear liner plates and billets. Customized and specific parts can also be engineered, including material grade modifications and bolt hole configurations.

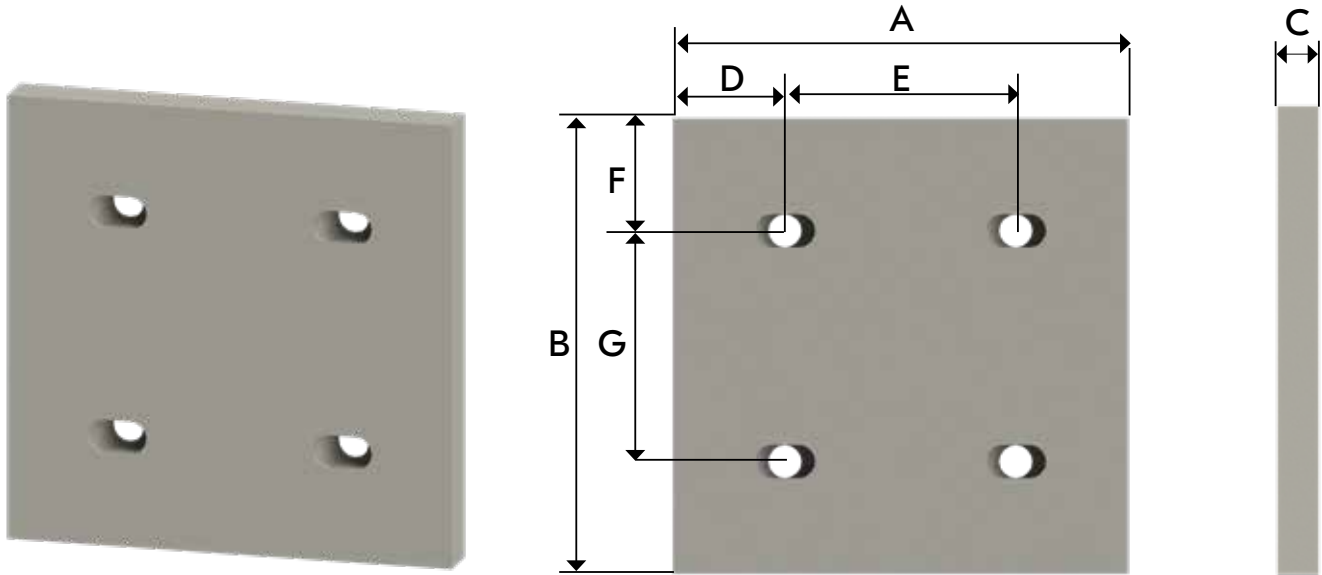

Standard high chrome white iron cast liner parts									
Part no.	Description	Dimensions (mm)							Mass (kg)
		A	B	C	D	E	F	G	
Standard liners – M16 fasteners									
ZX11711613	CP 300 x 300 x 25 M16	300	300	25	74	153	150	-	17
ZX11711616	CP 300 x 150 x 25 M16	300	150	25	74	153	75	-	9
ZX11927333	CP 300 x 300 x 32 M16	300	300	32	74	153	150	-	21
ZX11927334	CP 300 x 150 x 32 M16	300	150	32	74	153	75	-	11
ZX11927335	CP 300 x 300 x 40 M16	300	300	40	74	153	150	-	28
ZX11927336	CP 300 x 150 x 40 M16	300	150	40	74	153	75	-	14
ZX11927337	CP 300 x 300 x 50 M16	300	300	50	74	153	150	-	35
ZX11927338	CP 300 x 150 x 50 M16	300	150	50	74	153	75	-	17
Standard liners – M20 fasteners									
ZX11712737	CP 300 x 300 x 32 M20	300	300	32	74	153	74	153	21
ZX11927340	CP 300 x 150 x 32 M20	300	150	32	74	153	75	-	11
ZX11927341	CP 300 x 300 x 40 M20	300	300	40	74	153	74	153	28
ZX11927342	CP 300 x 150 x 40 M20	300	150	40	74	153	75	-	14
ZX11711619	CP 300 x 300 x 50 M20	300	300	50	74	153	74	153	35
ZX11711622	CP 300 x 150 x 50 M20	300	150	50	74	153	75	-	17

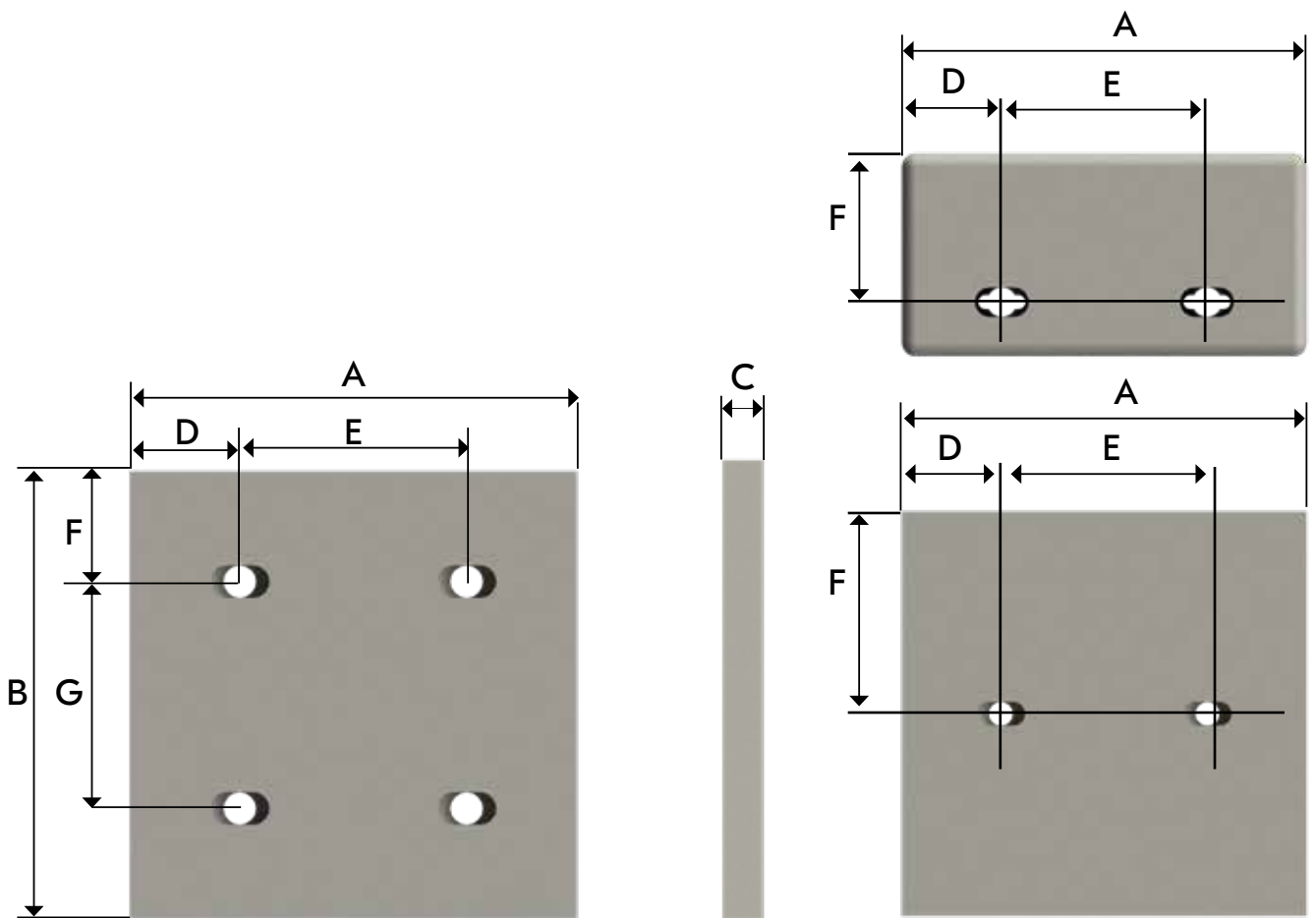

Standard high chrome white iron cast liner parts

Part no.	Description	Dimensions (mm)							Mass (kg)
		A	B	C	D	E	F	G	
Billets – M16 fasteners									
ZX11711629	CB 300 x 75 x 50 M16	300	75	50	73.5	153	37.5	-	8
ZX11835291	CB 300 x 75 x 75 M16	300	75	75	74	153	38	-	13
ZX11835292	CB 275 x 75 x 75 M16	275	75	75	49	153	38	-	12
Billets – M20 fasteners									
ZX11711641	CP 300 x 150 x 100 M20	300	150	100	74	152	40	-	33
ZX11712893	CP 302 x 100 x 100 M20	302	100	100	75	152	50	-	22
Stepped billets – M20 fasteners									
ZX11712911	CB 297 x 150 x 85/40 M20	297	150	85/40	72.5	152	65	-	21
ZX11711748	CB 300 x 180 x 80/50 M20	300	180	80/50	74	152	50	-	26
ZX11711607	CB 290 x 150 x 85/40 M20	290	150	85/40	70	150	65	-	21

Specialized high chrome white iron cast liner parts

Gridlock™ cast liner parts

A range of industry standard size high chrome iron cast wear liner parts incorporating the patented Gridlock anti-wash joint liner feature. Customized and specific parts can be engineered, including alternate material grades and bolt hole configurations.

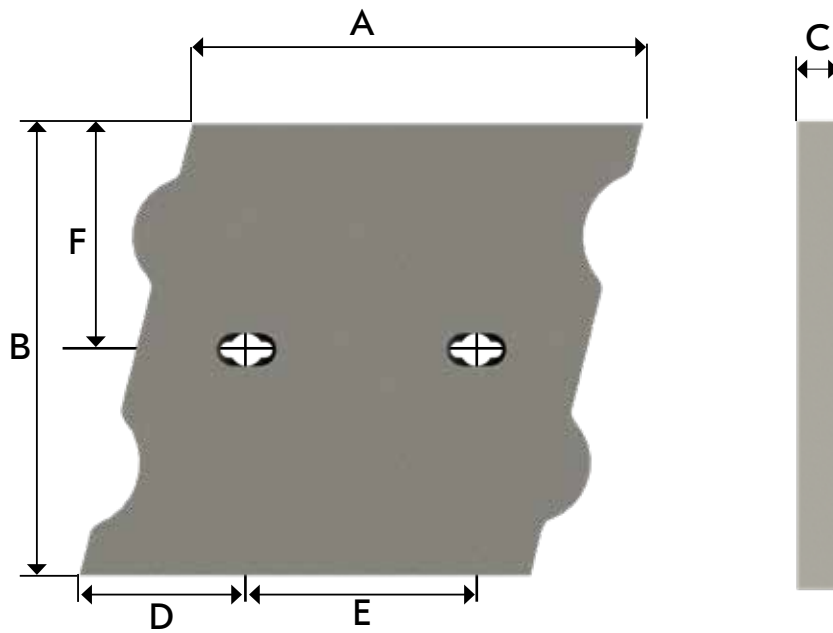

Gridlock™ cast liner parts									
Part no.	Description	Dimensions (mm)							Mass (kg)
		A	B	C	D	E	F	G	
ZX11711601	GL 300 x 300 x 30 M20	300	300	30	112	152	150	-	21
ZX11711604	GL 300 x 300 x 50 M20	300	300	50	112	152	150	-	33
ZX11710151	GL 300 x 385 x 50 M20	300	385	50	122	152	150	-	39
ZX11710258	GL 300 x 375 x 50 M20	300	375	50	175	100	150	-	23
ZX11710274	GL 300 x 375 x 50 M20	300	375	50	175	100	150	-	23
ZX11713237	GL 600 x 600 x 100 M20	600	600	100	76	300	130	340	280
ZX11765023	GL 600 x 748 x 100 M20	600	748	100	174	300	130	340	305
ZX11763486	GL 600 x 862 x 100 M20	600	862	100	178	300	130	340	320
ZX11765714	GL 600 x 827 x 100 M20	600	827	100	321	300	130	340	337

Rockbox and ribbed liner parts

A range of high chromium iron cast wear liner plates, based on industry standard sizes, incorporating Rockbox and ribbed design features that provide extended wear life through rock on rock wear characteristics. Customized and specific parts can be engineered, including alternate material grades and bolt hole configurations.

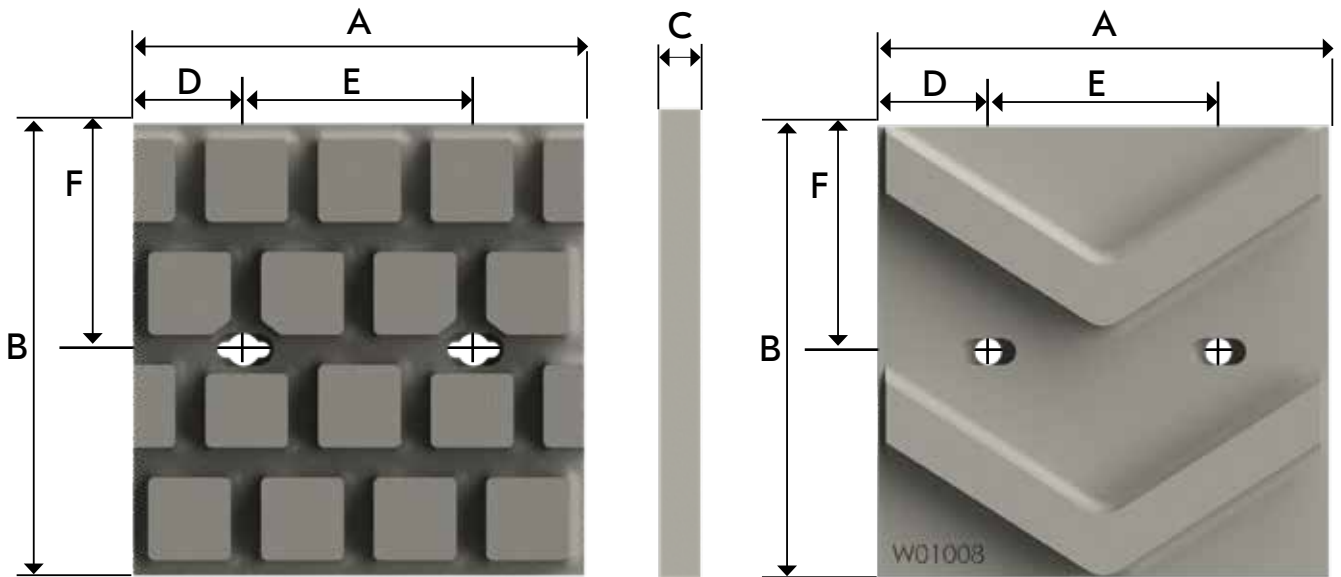

Rockbox and ribbed liner parts

Part no.	Description	Dimensions (mm)							Mass (kg)
		A	B	C	D	E	F	G	
ZX11711635	RB 300 x 300 x 57 M20	300	300	57	73.5	153	150	-	23
ZX11711638	RB 300 x 300 x 57 M20	300	300	57	73.5	153	150	-	29
ZX11713204	RB 300 x 300 x 63 M20	300	300	63	73.5	153	150	-	32
ZX11713206	RB 300 x 150 x 63 M20	300	150	63	74	152	75	-	16
ZX11738770	RB 300 x 300 x 63 M20	300	300	63	74	152	74	152	32
ZX11735573	RB 300 x 450 x 63 M20	300	300	63	74	152	73	304	50
ZX11735575	RB 450 x 150 x 63 M20	450	150	63	73	304	75	-	25

Fasteners for cast liner range

Metso Outotec offers a comprehensive range of oval head fasteners suited to the various cast wear liner products and accommodating various chute wall thicknesses. The parts list below provides a selection of the most commonly used oval head fasteners for cast liner products. Other fastener sizes are available and custom fasteners can also be manufactured as required. To maximize the benefit of utilizing Metso Outotec liner materials, consider combining it with our range of specialized fasteners as well as the complementary lifting and handling tooling.

Choice of materials

Oval head fasteners are manufactured typically to ISO 898 Grade 8.8 or SAE Grade 8 as a minimum. Other grades of oval head fasteners are also available, for example ASTM A320 Grade L7 for sub-zero service temperature applications.

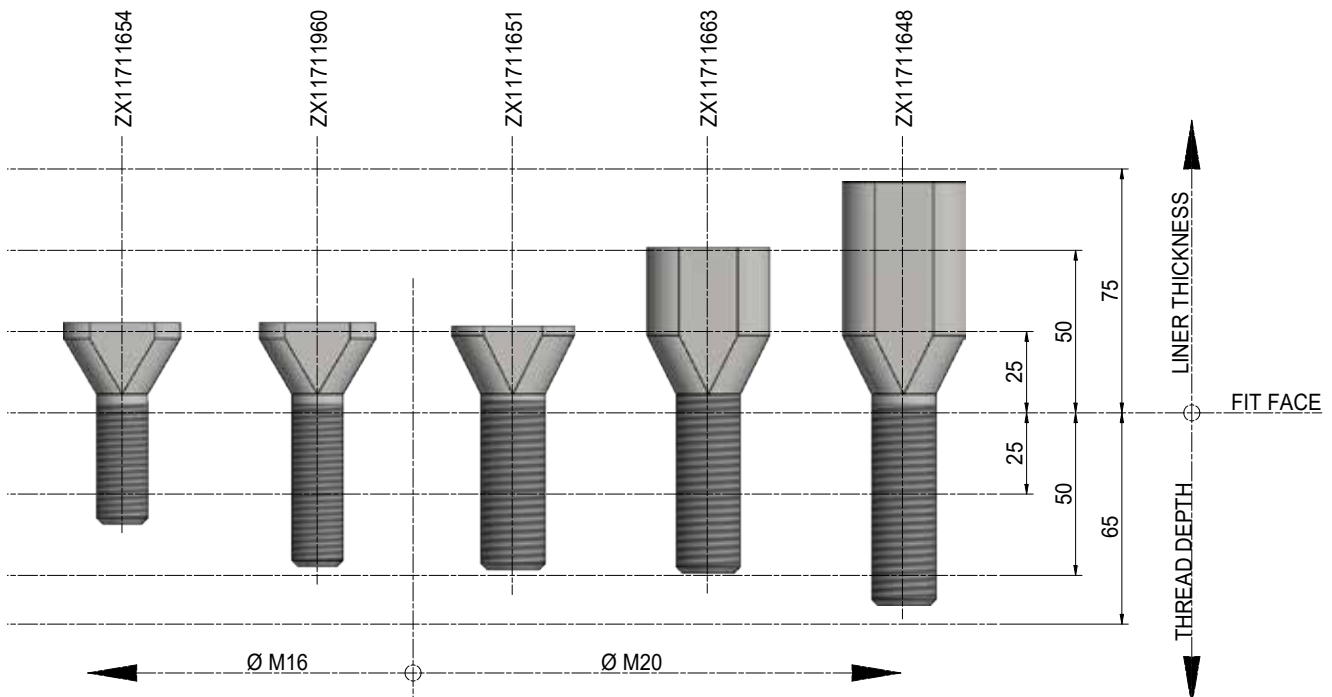

Fasteners product range		
Material no.	Description	Mass (kg)
ZX11711648	M20 x 130 Oval Head Bolt	0.48
ZX11711651	M20 x 75 Oval Head Bolt	0.2
ZX11711654	M16 x 62 Oval Head Bolt	0.1
ZX11711663	M20 x 100 Oval Head Bolt	0.3
ZX11711960	M16 x 75 Oval Head Bolt	0.2

Note: Other fastener sizes are available on request

Metal matrix composite wear liners

A range of industry standard size liner parts is readily available. Customized liner designs and matrix alloy/composite combinations can be created to suit specific requirements and applications, including alternate material grades and bolt hole configurations.

- Modular designs
- Increased wear life
- Reduced maintenance activities
- Lower overall operating costs



High chromium white cast iron/
Titanium carbide

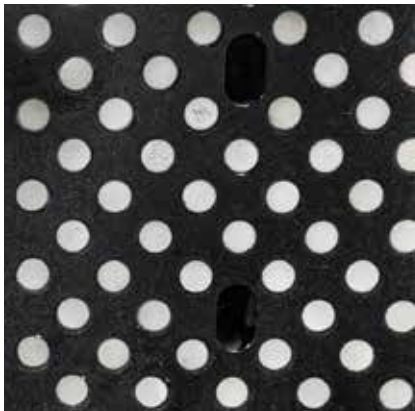

High chromium white cast iron/
Alumina

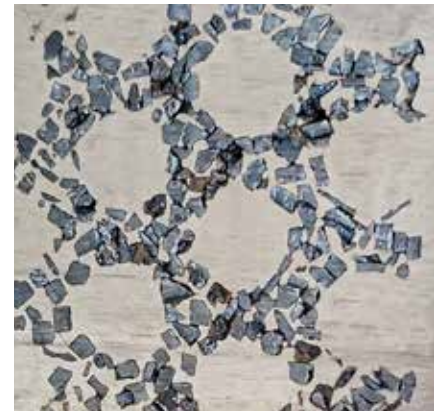

High chromium white cast iron/ZTA

Technical description

Metal matrix composite wear liners					
Part no.	Description	Matrix	Composite	Dimensions (W x L x T)	Mass (kg)
ZX11837241	MMC liner – Titanium carbide	High chrome white iron	Titanium carbide	300 x 300 x 50	32
ZX11712610	MMC liner – ZTA	High chrome white iron	ZTA	300 x 150 x 40	14
ZX11712612	MMC liner – ZTA	High chrome white iron	ZTA	300 x 300 x 40	26
ZX11932464	MMC liner – Alumina	High chrome white iron	Alumina	300 x 150 x 50	16
ZX11932465	MMC liner – Alumina	High chrome white iron	Alumina	300 x 300 x 50	32

Installation

Metal matrix composite wear liners can be applied to replace existing standard cast and plate liner elements, as well as customized liner applications, such as mill feed chutes, ledge liners, feeder wall liners and wear blocks. Installation is typically achieved with conventional hexagonal and oval head through-bolting systems, typically M16 and M20 fastener sizes.

Other information

Metal matrix composite wear liner elements are suitable for applications operating at ambient temperatures between -40°C to +120°C.

Atomx™ wear liner system

The Atomx wear liner developed by Metso Outotec is a hybrid design using cast wear-resistant element(s) bonded to a steel backing plate using rubber vulcanization. The hybrid design provides the combined benefits of impact and abrasive wear resistance when selected for the appropriate application.

- Modular design
- Industry standard part sizing
- Excellent combination of impact toughness and abrasion resistance



Technical description

Atomx wear liner system			
Part no.	Description	Dimensions (W x L x T) mm	Mass (kg)
ZX11713329	Atomx liner 32 mm	300 x 300 x 32	20
ZX11712626	Atomx liner 32 mm	150 x 300 x 32	10
ZX11712192	Atomx liner 50 mm	300 x 300 x 50	28
ZX11712195	Atomx liner 50 mm	150 x 300 x 50	14

Installation

The Atomx wear liner can be applied to replace existing standard cast and plate liner elements, where high abrasion resistance is required but where there is an increased likelihood of impact in demanding applications like impact plates, bins, and chutes.

Other information

Atomx wear liner elements are suitable for applications operating at ambient temperatures between -40°C to +70°C.

Xalloy™ plate

A comprehensive range of
metallic plate wear lining
solutions for any application



Xalloy™ plate

- Metallic plate materials tailored for each solution
- Excellent combination of wear resistance and impact resistance
- Unique modular designs and bulk offering available
- Can be combined with the Metso Outotec attachment systems, including wear side only fasteners

Utilizing a broad range of materials, from quench and tempered abrasion-resistant steel plate to directional weld overlay and fused overlay chromium carbide layers, Xalloy plate can provide the correct combination of abrasion wear resistance and impact resistance in a range of applications.

The benefit of using Xalloy plate can be maximized by combining them with the Metso Outotec range of specialized attachments and complementary lifting and handling systems to provide a complete chute lining solution.

Choice of materials

- Xalloy XO Plate - Directional weld overlay chromium carbide plate
- Xalloy FO Plate - Fused overlay chromium carbide plate
- Xalloy AR Plate - Abrasion-resistant quench and tempered plate

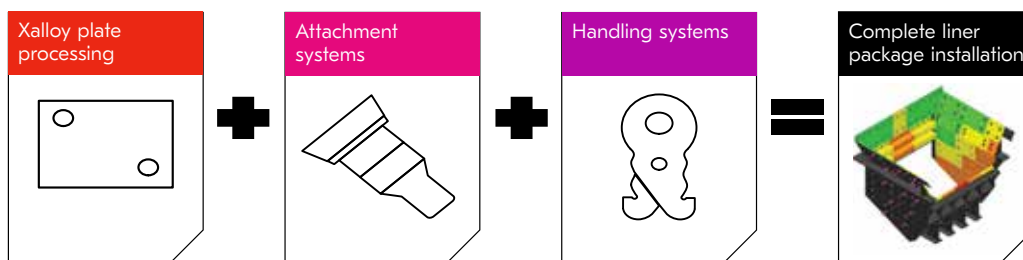

To maximize the benefit of utilizing Metso Outotec liner materials, consider combining it with our range of specialized fasteners as well as the complementary lifting and handling tooling.

Liner processing

Metso Outotec stocks a broad range of full Xalloy plate sheets in each of the referenced material grades and can provide complete processing services to supply customized liner packages for any application. The processing services available include profile cutting, countersunk holes, studding, forming and fabrication.

Xalloy plates can be formed into pipes, cones, and square to round transition pieces by rolling and pressing. There are some restrictions regarding the radius some plates can be rolled or pressed to and this varies based on plate type and thickness. Metso Outotec can advise on the specific restrictions related to each application.

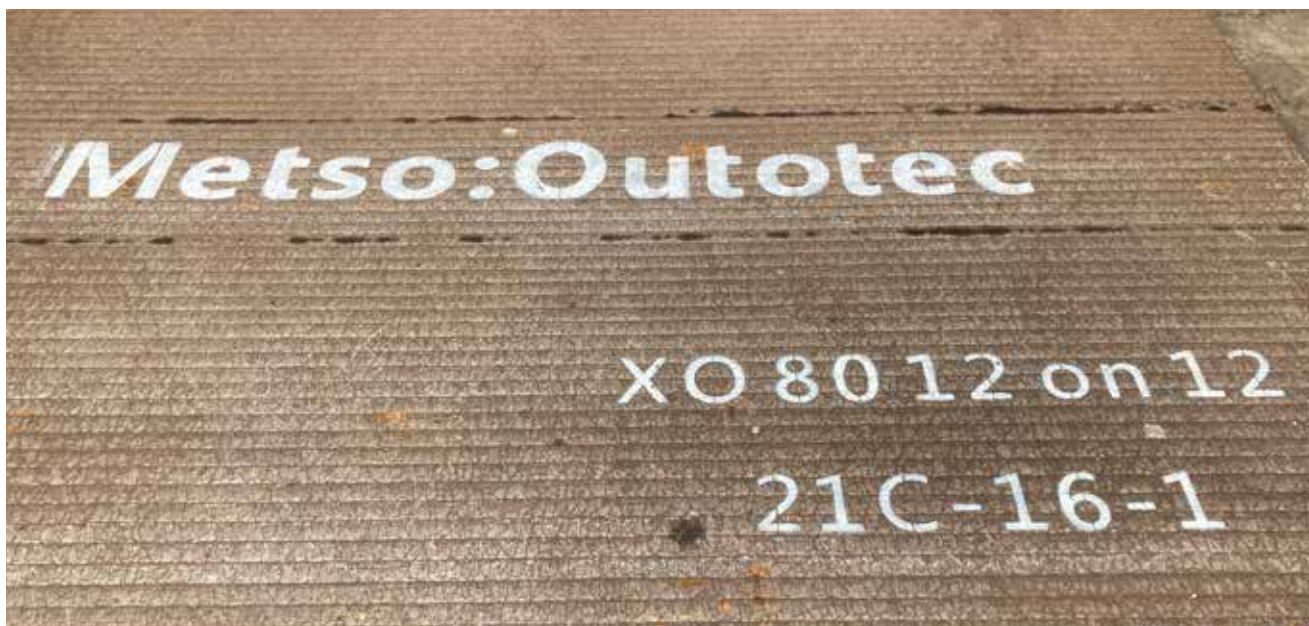

Xalloy plate installation

Xalloy plate provides an excellent combination of wear and impact protection in demanding applications like feeders, bins, transfer chutes, silos, transfer points and any other applications that are subject to heavy abrasive wear. Installation can be achieved using traditional stud welding or through-bolting systems, although Metso Outotec recommends combining Xalloy plate with one of our wear side only attachment systems to reduce installation time and improve safety. Metso Outotec provides full processing services to supply specific liner packages as required, including profiling, countersunk holes, studding, forming and fabrication.



Other information

Xalloy plate products can be selected for applications operating at ambient temperatures between -40°C to $+200^{\circ}\text{C}$.

Xalloy XO plate

Directional weld overlay chromium carbide plate

A highly alloyed chromium carbide overlay wear plate, consisting of a high chromium carbide alloy fused to a ductile mild steel plate. The weld overlay deposit is fully fused to the ductile backing plate to ensure optimum wear resistance combined with strength and toughness.

Material grades and applications

Xalloy XO60 CCO plate

A general purpose overlay plate offering good abrasion and impact resistance in applications such as transfer chutes, hoppers, bins and truck tray linings.

Xalloy XO80 CCO plate

For lining applications where increased resistance to abrasion and impact are required. Increased wear life is achieved compared to XO60.

Xalloy XO80T CCO plate

With an intentional tungsten (w) addition for high abrasion and high impact applications such as transfer chutes, reclaimer spill walls, stockpile bins and feeders.

Xalloy XO overlay plate range – Technical description

Grade	Overlay thickness (mm)	Backing plate thickness (mm)	Sheet size (mm)	Overlay direction
XO60	4	6	2,100 x 3,000	Along length
XO60	5	8	2,100 x 3,000	Along length
XO60	6	8	2,100 x 3,000	Along length
XO60	6	6	2,100 x 3,000	Along length
XO60, XO80	9	10	2,100 x 3,000	Along length
XO60, XO80	10	10	2,100 x 3,000	Along length
XO60, XO80	12	12	2,100 x 3,000	Along length
XO60, XO80	17	12	2,100 x 3,000	Along length or width
XO60, XO80	20	12	2,100 x 3,000	Along length or width
XO80, XO80T	25	10	2,100 x 3,000	Along length or width
XO80, XO80T	30	12	2,100 x 3,000	Along length or width
XO80, XO80T	40	20	2,100 x 3,000	Along length or width

Other information

	AR500 Plate	Xalloy XO60	Xalloy XO80	Xalloy XO80T
ASTM G65 abrasion mass loss	< 1.9g	< 0.26g	< 0.26g	< 0.15g
Hardness	565HV (500HB)	>630HV	>630HV	>700HV

Xalloy FO plate

Fused overlay chromium carbide plate

A premium smooth surface chromium carbide overlay plate manufactured using progressive laser gas shielded welding technology. The overlay has no directional weld beads and offers a consistent microstructure and high hardness down to the fusion zone with the high grade ductile mild steel backing plate.

Material grades and applications

Xalloy FO60

For high abrasion, high impact and flow critical applications such as truck body linings.

Xalloy FO100

For high abrasion, medium impact and flow critical applications such as feeders, silos and load out bins.

Xalloy FO200

For extreme abrasion, high impact and flow critical applications such as transfer chutes, feeders and stockpile bins.

Xalloy FO overlay plate range – Technical description			
Grade	Overlay thickness (mm)	Backing plate thickness (mm)	Plate size (mm)
FO60	4	6	1,200 x 3,600
FO60	6	6	1,200 x 3,600
FO60	9	10	1,200 x 3,600
FO60	10	10	1,000 x 3,600
FO60	12	12	1,000 x 3,600
FO100	5	5	1,000 x 3,000
FO100	6	7	1,000 x 3,000
FO100, FO200	8	8	1,000 x 3,000
FO100, FO200	10	10	1,000 x 3,000
FO100, FO200	12	12	1,000 x 3,000
FO100, FO200	17	12	1,000 x 3,000
FO100, FO200	20	12	1,000 x 3,000
FO100, FO200	25	12	1,000 x 3,000

Other information				
	AR500 plate	Xalloy FO60	Xalloy FO100	Xalloy FO200
ASTM G65 Abrasion mass loss	< 1.9g	< 0.18g	< 0.15g	< 0.10g
Hardness	565HV (500HB)	>670HV	>670HV	>670HV

Xalloy™ AR plate

Abrasion-resistant quench and tempered plate

The Metso Outotec Xalloy abrasion-resistant plate is a quench and tempered rolled steel plate available in various hardness ranges for applications requiring combined impact and abrasion resistance.

- Controlled chemistry and heat treatment processing
- Excellent combination of impact toughness and wear resistance
- Unique modular designs and bulk offering available

Material grades and applications

The increasing hardness across the AR plate range, from AR400 (400HB) to AR600 (600HB), provides for increasing levels of abrasion resistance and a relative decline in impact toughness. This allows each application to be matched ideally to the right plate grade. Typically, the AR plate range provides a more economical solution, compared to XO and FO plate products, for applications requiring primarily good impact toughness as well as good resistance to abrasion.

Xalloy quench and tempered abrasion-resistant plate – Technical description

Grade	Thickness range (mm)	Typical mechanical properties		
		Hardness (HB)	Tensile strength (MPa)	Impact strength (J @ -40C)
AR400	8 - 100	370 - 430	1,280 - 1,510	40
AR450	8 - 100	410 - 475	1,430 - 1,700	30
AR500	8 - 75	470 - 530	1,650 - 1,850	25
AR600	8 - 65	550 - 640	1,930 - 2,200	20
Xtreme	8 - 19	600 - 700	>2,200	15

Other information

The Metso Outotec abrasion-resistant plate can be welded in accordance with relevant welding standards. Preheating is recommended for welding operations and post heating is generally not required; however, controlled cooling after welding is recommended.

Xalloy plate fixing methods

All types and grades of Xalloy plate, from XO to FO to AR products, can be attached using conventional systems, such as through-bolting, weld on studs, plug welded inserts or direct welding. However, significant reductions in installation time and improvements in safety can be achieved by combining Xalloy plate with the Metso Outotec range of specialized wear side only attachments and utilizing the complementary lifting and handling systems. Metso Outotec provides full processing services to supply specific liner packages as required, including profiling, countersunk holes, studding, forming and fabrication.

Xblock™

A comprehensive range of
bimetallic wear protection
solutions for any application



Xblock bimetallic wear products

The Metso Outotec range of bimetallic wear blocks, chocky blocks, wear buttons and donuts comprise a high hardness chromium molybdenum alloyed cast iron wear element that has been metallurgically bonded to a weldable steel backing plate.

- High hardness abrasion resistance
- A wide range of industry standard shapes and sizes
- Custom solutions are also available

Bimetallic wear products provide a fast and flexible option for wear protection, particularly suited to quick installs during unplanned shutdowns and isolated repairs. The products are typically welded into position using standard welding processes and can also be installed by attaching weld on stud fasteners.



Xblock bars and blocks

Xblock wear bars and blocks can be used to form a rock box in transfer chute applications and are often also used for wear protection on mobile plant and equipment accessories.

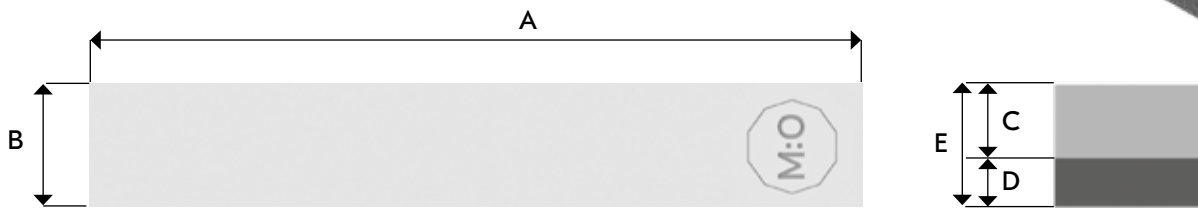
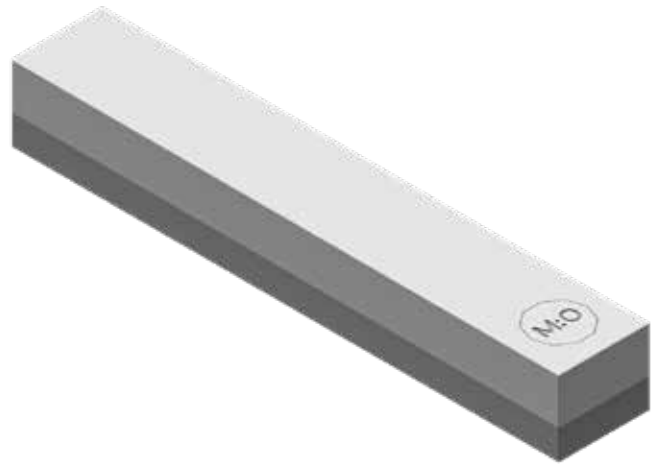

Xblock bars and blocks							
Part no.	Description	Dimensions mm					Mass (kg)
		A	B	C	D	E	
ZX11926713	XB 200x25x25	200	25	15	10	25	1.0
ZX11926997	XB 300x25x25	300	25	15	10	25	1.5
ZX11927008	XB 195x25x30	195	25	20	10	30	1.1
ZX11927145	XB 459x38x31	459	38	25	6	31	4.2
ZX11927146	XB 153x38x33	153	38	25	8	33	1.5
ZX11927147	XB 300x38x33	300	38	25	8	33	3.0
ZX11927178	XB 102x33x33	102	33	25	8	33	0.9
ZX11927179	XB 190x50x30	190	50	20	10	30	2.2
ZX11712529	XB 115x50x50	115	50	40	10	50	2.2
ZX11732992	XB 150x50x50	150	50	40	10	50	2.9
ZX11712202	XB 210x50x50	210	50	38	12	50	4.1
ZX11712205	XB 230x50x50	230	50	38	12	50	4.5
ZX11927258	XB 254x50x50	254	50	40	10	50	5.0
ZX11927259	XB 294x50x50	294	50	40	10	50	5.7
ZX11712531	XB 300x50x50	300	50	38	12	50	5.8
ZX11712210	XB 432x50x50	432	50	38	12	50	8.5
ZX11927260	XB 600x50x50	600	50	38	12	50	11.8



Xblock bars and blocks

Part no.	Description	Dimensions mm					Mass (kg)
		A	B	C	D	E	
ZX11927261	XB 230x50x60	230	50	40	20	60	5.4
ZX11927268	XB 203x51x20	203	51	12	8	20	1.6
ZX11927269	XB 254x51x20	254	51	12	8	20	2.0
ZX11927270	XB 127x51x48	127	51	38	10	48	2.4
ZX11927271	XB 250x60x20	250	60	12	8	20	2.4
ZX11927272	XB 150x75x39	150	75	29	10	39	3.4
ZX11927273	XB 150x75x50	150	75	40	10	50	4.4
ZX11927274	XB 150x75x60	150	75	50	10	60	5.3
ZX11927275	XB 200x75x75	200	75	63	12	75	8.8
ZX11941163	XB 150x75x75	150	75	63	12	75	6.6
ZX11941164	XB 250x75x75	250	75	63	12	75	11.0
ZX11967022	XB 300x75x75	300	75	63	12	75	13.2
ZX11941165	XB 340x75x75	340	75	63	12	75	15.0
ZX11927277	XB 294x80x50	294	80	38	12	50	9.2
ZX11927278	XB 241x100x58	241	100	38	20	58	11.0
ZX11927279	XB 300x150x60	300	150	48	12	60	21.0
ZX11902065	XB 240x100x100	240	100	80	20	100	18.84
ZX11957348	XB 300x100x100	300	100	80	20	100	23.5

Xblock chocky blocks

Choky blocks can be formed, cut and welded onto flat or curved surfaces. This allows them to be used on a wide range of fixed plant and mobile equipment such as buckets and chute liners.



Xblock chocky blocks							
Part no.	Description	Dimensions mm					Mass (kg)
		A	B	C	D	E	
ZX11927280	XBCB 240 x 25 x 23	240	25	15	8	23	0.9
ZX11712177	XBCB 240 x 40 x 23	240	40	15	8	23	1.5
ZX11712180	XBCB 240 x 50 x 23	240	50	15	8	23	1.9
ZX11712184	XBCB 240 x 65 x 23	240	65	15	8	23	2.5
ZX11927281	XBCB 240 x 80 x 23	240	80	15	8	23	3.2
ZX11902064	XBCB 240 x 90 x 23	240	90	15	8	23	3.0
ZX11927282	XBCB 240 x 100 x 23	240	100	15	8	23	3.9
ZX11927283	XBCB 240 x 130 x 23	240	130	15	8	23	5.2
ZX11927284	XBCB 240 x 100 x 23	240	150	15	8	23	7.3

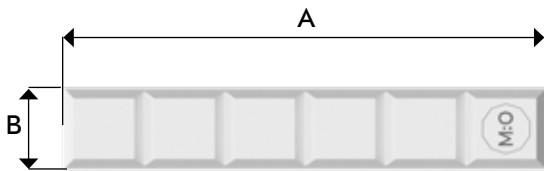

Xblock plates

Xblock plates and blocks can be used to replace conventional metallic wear liners, for edge protection on shelves and ledges, and to form a rock box. They are also used to provide protection on earth-moving equipment such as buckets and shovels.

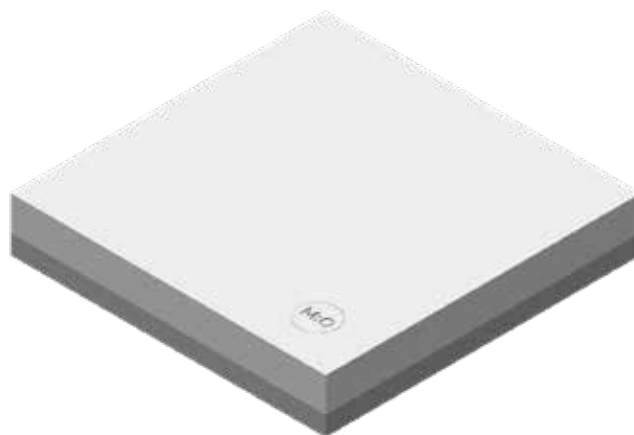

Xblock plates							
Part no.	Description	Dimensions mm					Mass (kg)
		A	B	C	D	E	
ZX11902066	XBP 300 x 300 x 30	300	300	20	10	30	21.2
ZX11902067	XBP 300 x 150 x 30	300	150	20	10	30	10.6
ZX11902068	XBP 300 x 450 x 30	300	450	20	10	30	31.8

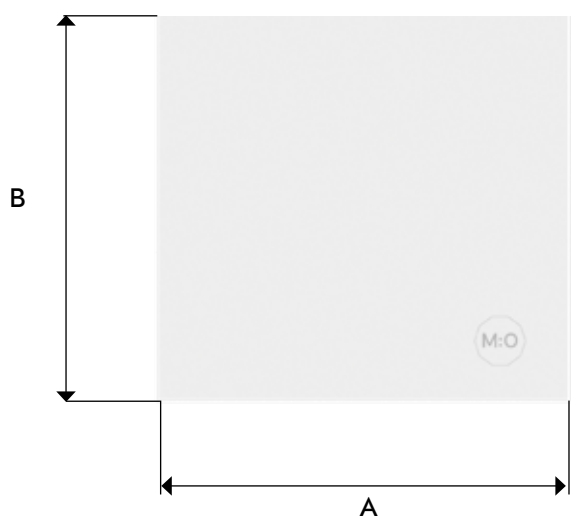

Xblock buttons

Wear buttons are commonly used on heavy earth-moving equipment, particularly on mining and construction buckets and shovels.



Xblock buttons							
Part no.	Description	Dimensions mm					Mass (kg)
		A	B	C	D	E	
ZX11712213	XB 75 x 27	75	27	17	10	-	0.8
ZX11712216	XB 90 x 27	90	27	17	10	-	1.5
ZX11712219	XB 115 x 32	115	32	20	12	-	2.5
ZX11712222	XB 150 x 41	150	41	25	16	-	5.7



Xblock donuts

Xblock donuts are commonly used as peripheral protection for fastener locations and other openings on fixed and mobile plants.



Xblock donuts							
Part no.	Description	Dimensions mm					Mass (kg)
		A	B	C	D	E	
ZX11862034	XD 75(25) x 25	75	25	17	8	25	0.7
ZX11927285	XD 100(50) x 25	100	50	17	8	25	1.0
ZX11927286	XD 100(70) x 32	100	70	24	8	32	1.0
ZX11927287	XD 130(80) x 23	130	80	15	8	23	1.3

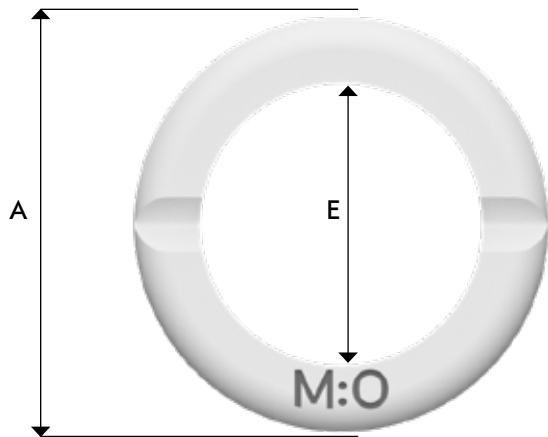

Xblock shaped bars

Shaped bars are typically used to prevent abrasion and gouging wear on the leading edges of plants and equipment such as buckets and moving parts.

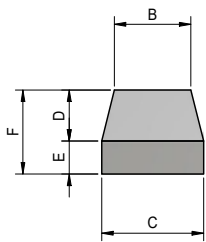
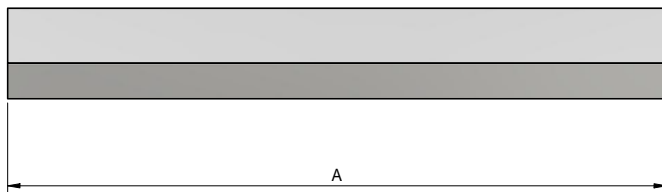
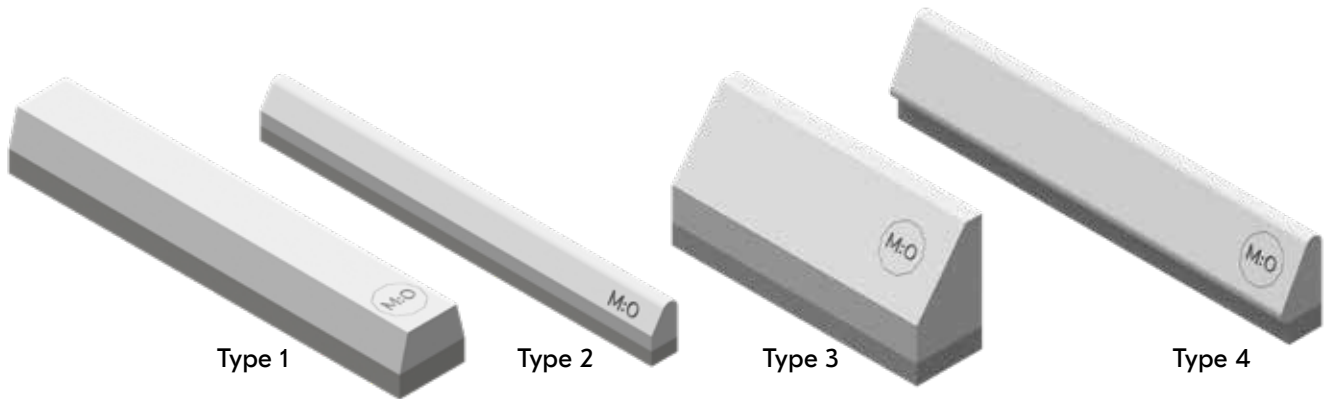

Type 1

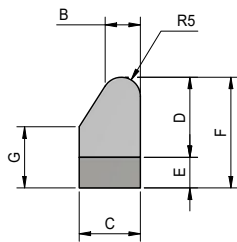

Type 2

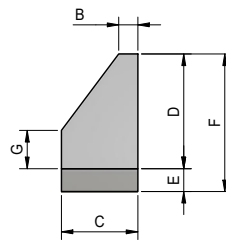

Type 3

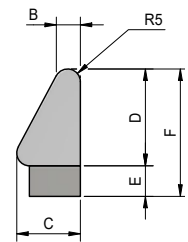

Type 4

Xblock shaped bars									
Part no.	Description	Dimensions mm							Mass (kg)
		A	B	C	D	E	F	G	
Type 1									
ZX11927288	XBS 200 x 20 x 30	200	13	20	20	10	30	-	0.8
ZX11927289	XBS 244 x 25 x 35	244	10	25	25	10	35	-	1.4
ZX11927290	XBS 202 x 25 x 35	202	10	25	25	10	35	-	0.9
Type 2									
ZX11927291	XBS 275 x 16 x 29	275	5	16	21	8	29	16	0.9
Type 3									
ZX11927292	XBS 150 x 40 x 70	150	10	40	50	10	70	20	2.4
ZX11927293	XBS 200 x 25 x 59	200	3	25	47	12	59	-	1.3
Type 4									
ZX11927294	XBS 125 x 40 x 90	125	10	70	80	10	90	-	4.3
ZX11927295	XBS 200 x 25 x 50	200	10	25	38	12	50	-	1.5

Xblock grizzly bars

Grizzly bar caps provide wear protection for largesize screening applications across various mining, quarrying and processing plant installations.

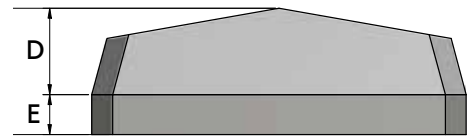
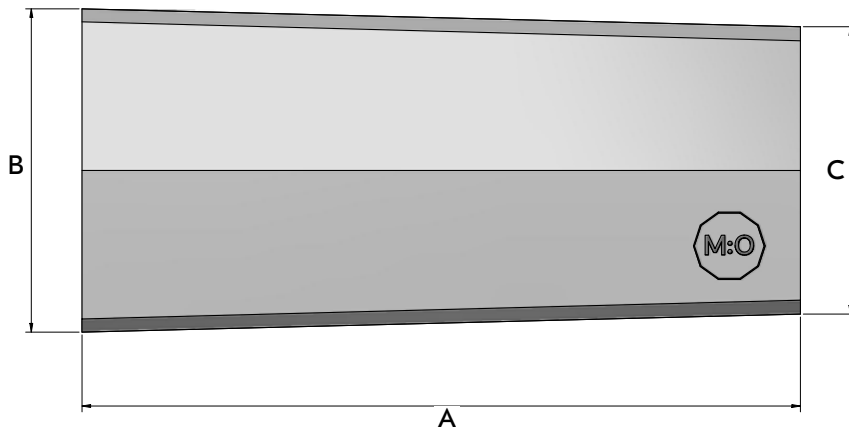
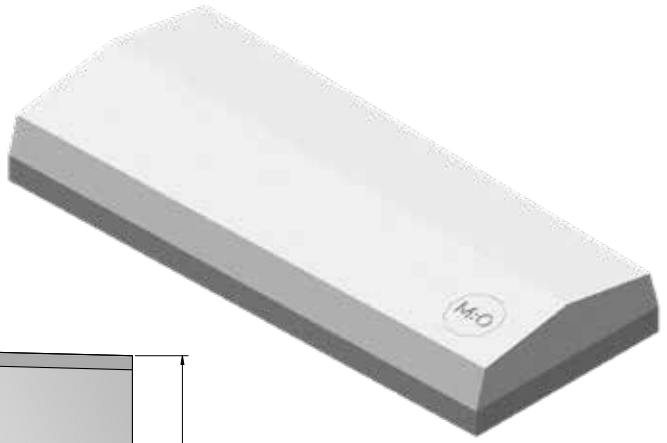

Xblock grizzly bars							
Part no.	Description	Dimensions mm					Mass (kg)
		A	B	C	D	E	
ZX11927296	XBG 305 x 150 x 137.5	305	150	137.5	38	12	13.5
ZX11927297	XBG 305 x 137.5 x 125	305	137.5	125	38	12	12.5
ZX11927298	XBG 305 x 125 x 112.5	305	125	112.5	38	12	11.2
ZX11927299	XBG 305 x 112.5 x 100	305	112.5	100	38	12	10.0
ZX11927300	XBG 305 x 100 x 87.5	305	100	87.5	38	12	8.8
ZX11927301	XBG 305 x 87.5 x 75	305	87.5	75	38	12	7.5
ZX11927302	XBG 305 x 75 x 62.5	305	75	62.5	38	12	6.3
ZX11927303	XBG 305 x 62.5 x 50	305	62.5	50	38	12	5.1
ZX11927304	XBG 305 x 150 x 141	305	150	141	38	12	13.8
ZX11927305	XBG 305 x 141 x 131	305	141	131	38	12	12.9
ZX11927306	XBG 305 x 131 x 122	305	131	122	38	12	11.9
ZX11927307	XBG 305 x 122 x 113	305	122	113	38	12	11.1
ZX11927308	XBG 305 x 113 x 103	305	113	103	38	12	10.1
ZX11927309	XBG 305 x 103 x 94	305	103	94	38	12	9.2
ZX11927310	XBG 305 x 94 x 84	305	94	84	38	12	8.3
ZX11927311	XBG 305 x 84 x 75	305	84	75	38	12	7.4

Xblock skid bars

Skid bars are used to extend the life of mining and quarrying equipment such as large buckets for wheel loaders, excavators and shovels.

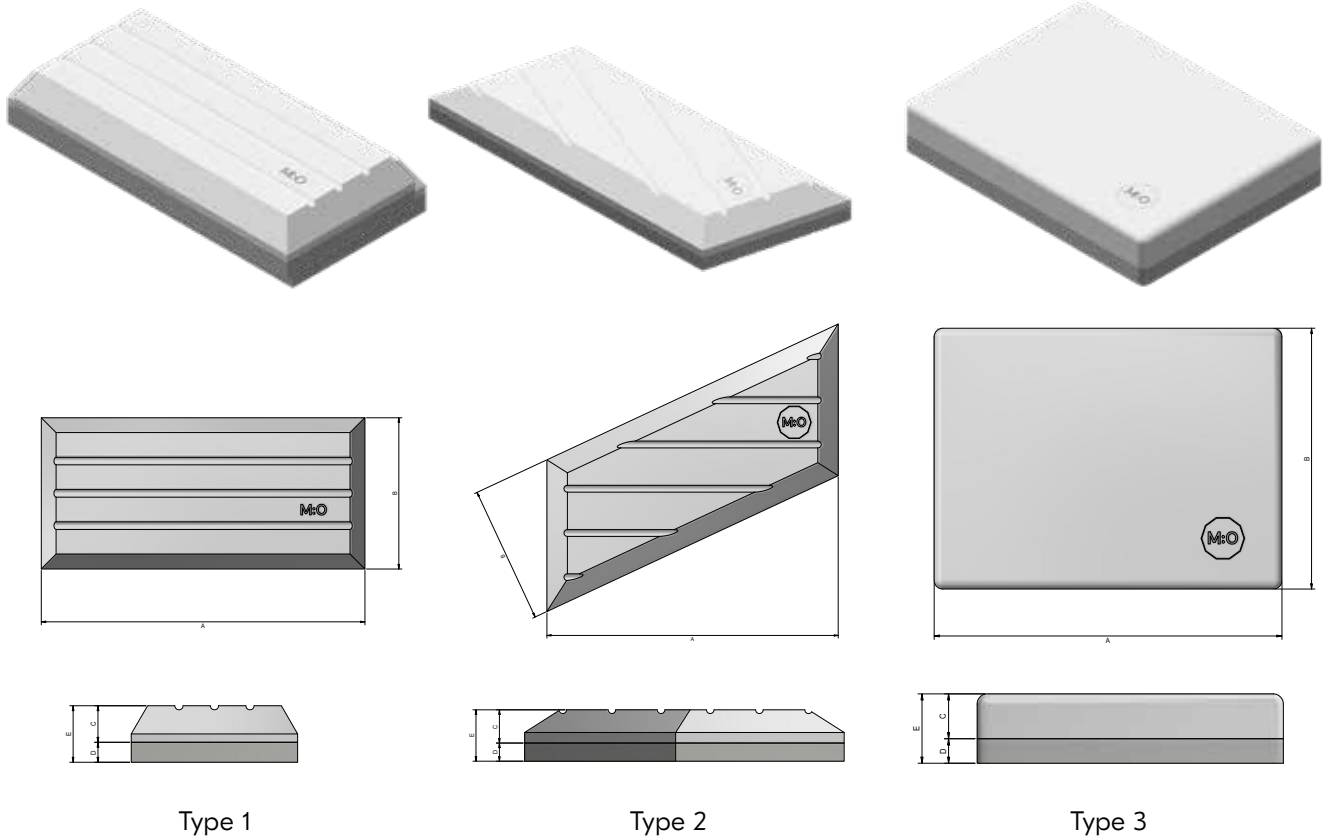

Type 1

Type 2

Type 3

Xblock skid bars							
Part no.	Description	Dimensions mm					Mass (kg)
		A	B	C	D	E	
Type 1							
ZX11927312	XBSB 214 x 101 x 34	214	101	22	12	34	5.1
ZX11927313	XBSB 302 x 101 x 34	302	101	22	12	34	7.3
ZX11927314	XBSB 154 x 101 x 34	154	101	22	12	34	3.7
ZX11927315	XBSB 279 x 75 x 34	279	75	22	12	34	6.1
Type 2							
ZX11927316	XBSB 214 x 101 x 34	214	101	22	12	34	5.9
ZX11927317	XBSB 304 x 101 x 34	304	101	22	12	34	8.4
ZX11927318	XBSB 154 x 101 x 34	154	101	22	12	34	4.2
Type 3							
ZX11927319	XBSB 250 x 150 x 45	250	150	20	25	45	13.1
ZX11927320	XBSB 200 x 150 x 45	200	150	20	25	45	10.5
ZX11927321	XBSB 250 x 250 x 45	250	250	20	25	45	21.9

Rubber wear lining

Rubber wear lining

Trellex wear elements includes a wide range of basic wear plates manufactured in rubber. The wear elements provide first-class wear protection in applications that are subject to wear and noise.

Wear-life improvement

Improve the wear life of the original equipment by protecting it with rubber wear elements — for wet or dry applications, small or large material sizes and different impact angles. All elements help to achieve the maximal lifetime and production capacity.

Flow improvement

Improve poor material flow caused by a narrow sector in the process. Such spots can be real bottlenecks and create a lot of additional work and unplanned downtime.

Noise reduction

Excessive noise is a problem in mining and aggregate operations, so managing noise pollution is more important than ever. All wear rubber products reduce noise and thereby contribute to a better work environment.



Trellex PP

Manufactured from T60 wear rubber and combined with hot-vulcanized steel reinforcement. Provide first-class wear protection in tough applications like truck beds, primary chutes, etc. and for secondary applications such as chutes, feeders, channels, silos and other applications that are subject to wear and noise.



Trellex PT

Manufactured from T60 wear rubber and include hot-vulcanized aluminum fixing profiles, provide excellent wear resistance in applications with both impact and sliding wear. The vulcanized aluminum profiles allow for fewer fixing points than steel-reinforced wear plates.



Trellex SB

Manufactured from T60 wear rubber with molded holes for fixing. The holes are reinforced with fixed hot-vulcanized internal steel washers. Provide excellent wear resistance in applications with both impact and sliding wear. The wear plates are bendable and easy to cut.



Trellex WB

Manufactured from T60 wear rubber and include hot-vulcanized aluminum fixing profile. Excellent wear resistance in applications with both impact and sliding wear. The embedded aluminum profile allows for fewer fixing points than steel-reinforced wear plates.



Trellex Flexback

Excellent wear resistance in lighter and medium applications. The reinforcement makes it possible to construct self-supporting channels and chutes with simple supports of angle iron and flat iron and provides excellent wear protection for chutes, channels, bins and other applications that are subject to wear and noise.

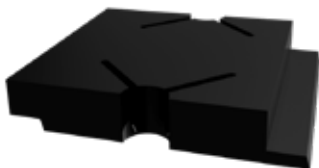

Trellex SQ300 rubber

Modern, environmentally friendly wear protection system reduces impacts and improves health and safety without increasing costs or sacrificing operational efficiency. Designed for simplicity of installation and minimum downtime by using a patented fastening system. Easy to cut using a knife or alu-cut machine.

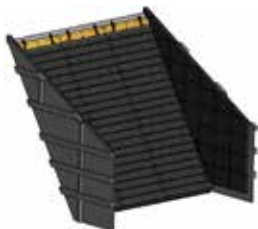

Microledge

Rubber curtains designed to fit all types of chutes and hoppers processing wet fines. Self-cleaning properties significantly reduce the build-up of fines and sticky materials that cause blockages.

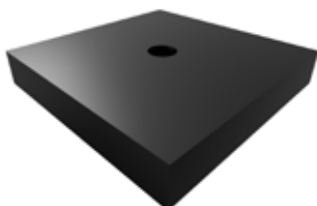

Xlok™ rubber

Tough modular liner system and the ultimate choice for situations where equipment can only be accessed from the inside. Available in a range of material options to suit the application, including cast metallic options, rubber and ceramic products.

Trellex wear improvement lining guide

Identify your critical areas for improvement and let the selection guide help you find the product that brings the most value to your application. Your choice will be based on processing conditions, material size, shape, drop height, volume, angle of impact, etc. Improve the wear life of lining applications with Trellex lining products. Trellex offers a wide range of various lining products suitable for any application – wet or dry applications, small or large material sizes and different impact angles.

Below is an overview of Trellex products for various applications. Some products overlap and can be used in the same application.



General flow improvement lining guide

Lining products for flow improvement are available in a range of options, based on abrasion rate and capacity. Below is an overview of products for various areas of use. Some products overlap and can be used in various applications.

High abrasion rate

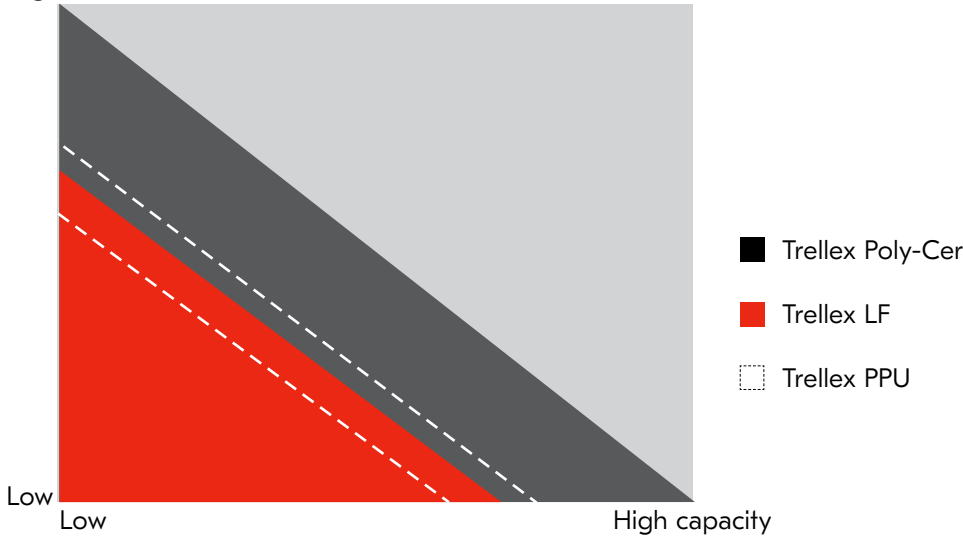

General noise reduction lining guide

Excessive noise is a problem in mining and aggregate operations. Managing noise pollution is more important than ever. All wear rubber products, such as Trellex PP, Trellex SP, Trellex PT, Trellex SB, Trellex WB, Trellex SQ, Trellex Flexback and Trellex Poly-Cer, will help to reduce noise levels by up to 20 decibels. Reducing the noise level by 10 decibels corresponds to the perceived effect of cutting the noise in half. Less noise means better work conditions.

Diagram sound level - Primary chute

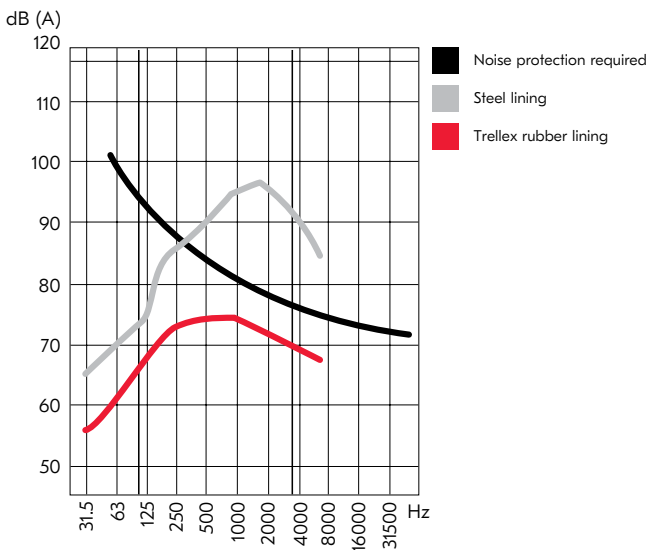
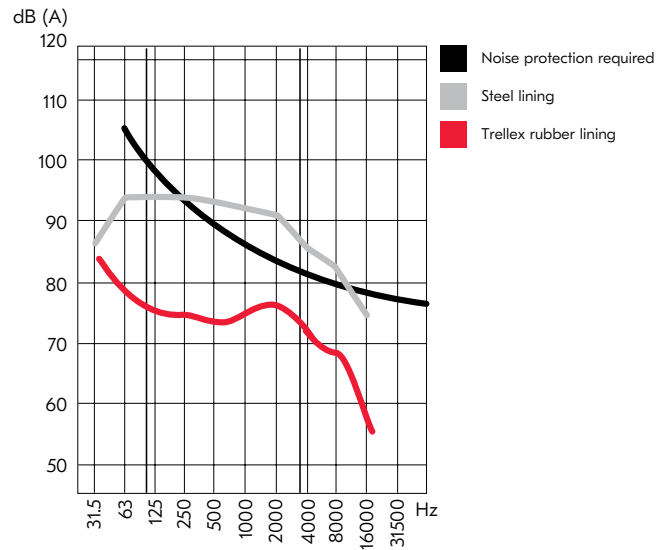

Diagram sound level - Loading truck



Environmental effects on lining products

Water

(recommendations valid for handled material temperature up to 30°C (86°F))

RU Components	
pH range	Comment
pH 2 – 13	No effect on RU
pH 2 – 4	Stainless steel recommended for metal parts exposed to handled material
pH 4 – 9	No effect on steel or aluminum parts exposed to handled material
pH 9 – 11	Some effect on aluminum parts. Steel parts recommended for long wear life
pH 11 – 13	Steel parts recommended for metal parts exposed to handled material

PU Components	
pH range	Comment
pH 2 – 13	No effect on PU standard quality
	Stainless steel / aluminum / steel parts same recommendation as rubber components

Temperatures

PU Components	
Temperature range	Comment
-25 to +70°C (-13 to + 158°F)	No effect on RU
+70 to +120°C (+158 to +248°F)	Not recommended; ask product specialist
-60 to -25°C (-76 to -13°F)	Ask product specialist

RU Components	
Temperature range	Comment
-25 to +70°C (-13 to +158°F)	No effect on RU

Environmental effects on lining products

Chemicals

RU components

SBR withstands moderate concentrations of chemicals and oils.

NR withstands low concentrations of oil.

PU components

Resists smaller concentrations of sodium, salts, calcium and glycerine. Good resistance to nitrogen, mineral oil, carbon dioxide, carbon monoxide and ASTM oil 1 - 3.

Storage

RU and PU components must be protected from sunlight, excessive heat and ozone.

Avoid deformation of rubber and PU components when stacked and stored.

Indoor storage is recommended when storing rubber and PU components for longer than 6 months.

Storage of rubber sheeting without contact layer (CL)

Max. 24 months.

At 25 °C \pm 2 °C with no loss in quality.

Subject to DIN regulation 7716.



Trellex PP

Trellex PP wear plates are manufactured from T60 wear rubber combined with hot-vulcanized steel reinforcement plates.



Wear elements made of rubber provide:

- Excellent wear resistance
- Outstanding impact absorption
- Hot-vulcanized steel reinforcement

Excellent wear resistance in applications with both impact and sliding wear. The steel backing prevents small particles from getting under the lining and guarantees secure fixing. Rubber wear plates reduce noise and vibrations and are lighter compared to conventional steel linings.

Choice of materials

Trellex PP wear elements are manufactured from wear-resistant rubber with excellent performance in applications with impact and sliding wear. Trellex PP wear elements are available in thicknesses ranging from 13 mm to 150 mm and are manufactured in standard dimensions.

Technical description

Resists pH values 4-11 and all water types, and most oils and chemicals in moderate/small concentrations.

Other information

Trellex PP is most effective in the -25° to $+70^{\circ}\text{C}$ temperature range.

Installation

Trellex PP wear plates provide first-class wear protection in demanding applications like primary chutes and for secondary applications such as chutes, feeders, channels, silos and other applications that are subject to wear and noise. For use with medium to heavy mining and aggregate industry within both wet and dry applications. Trellex PP can be installed using a through-bolt system or with a stud welded bolt system. For lighter applications, a plug weld system or self-tapping system can be used.

Trellex PP standard range

Part no.	Description	Width x Length (mm)	Weight (kg/ea)
631804	PP 13/3	1,500 x 3,000	156
881763	PP 15 /3	1,500 x 3,000	166
631812	PP 18/3	1,500 x 3,000	182
2327930	PP 20/5	1,500 x 3,000	251
2127190	PP 20/3	1,500 x 3,000	192
511402	PP 23/3	1,500 x 3,000	208
881714	PP 25/5	1,500 x 3,000	277
881698	PP 25/3	1,500 x 3,000	218
881722	PP 30/5	1,500 x 3,000	303
881706	PP 30/3	1,500 x 3,000	244
73031	PP 30/5	500 x 1,000	34
73171	PP 30/5	600 x 1,000	61
73049	PP 30/5	500 x 1,500	50
73189	PP 30/5	600 x 1,500	60
361170	PP 30/5	750 x 1,500	76
361170-P3	PP 30/3	750 x 1,500	58
881730	PP 40/5	1,500 x 3,000	355
73056	PP 40/5	500 x 1,000	41
73197	PP 40/5	600 x 1,000	45
73064	PP 40/5	500 x 1,500	59
73205	PP 40/5	600 x 1,500	71
574178	PP 40/5	750 x 1,500	88
680031	PP 50/5	500 x 1,000	44
680033	PP 50/5	600 x 1,000	47
680035	PP 50/5	750 x 1,000	67
680032	PP 50/5	500 x 1,500	67
680034	PP 50/5	600 x 1,500	81
680036	PP 50/5	750 x 1,500	101
73320	PP 55/5	750 x 1,500	106
881748	PP 55/5	1,500 x 3,000	406
680041	PP 75/5	500 x 1,000	59
680042	PP 75/5	500 x 1,500	89
680043	PP 75/5	600 x 1,000	71
680044	PP 75/5	600 x 1,500	107
680045	PP 75/5	750 x 1,000	89
680046	PP 75/5	750 x 1,500	133
73346	PP 80/5	750 x 1,500	144
6680088	PP 100/5	500 x 500	36
680051	PP 100/5	500 x 1,000	72
680053	PP 100/5	600 x 1,000	86
680052	PP 100/5	500 x 1,500	110
680054	PP 100/5	600 x 1,500	132
680056	PP 100/5	750 x 1,500	166
680061	PP 125/5	500 x 1,000	86
680063	PP 125/5	600 x 1,000	104
680062	PP 125/5	500 x 1,500	132
680066	PP 125/5	750 x 1,500	198
680071	PP 150/5	500 x 1,000	101
680073	PP 150/5	600 x 1,000	121
680072	PP 150/5	500 x 1,500	153
680076	PP 150/5	750 x 1,500	230

Custom-made dimensions upon request.

Fixing methods - Trellex PP

For all PP13-PP150 wear plates

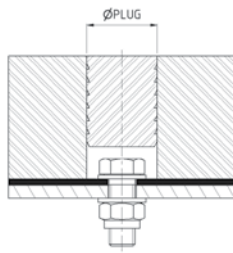

Through-bolt system

Trellex PP	ØD	Ød	Plug	Bolt	Torque (Nm)
PP 13 - 40	40	14	45/35	M12	80
PP 50 - 75	54	18	60/50	M16	190
PP 100 - 150	54	22	60/50	M20	370

PP13-PP28 no standard plug.

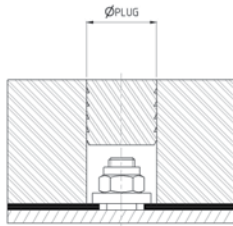

Stud-bolt system

Trellex PP	ØD	Ød	Plug	Bolt	Torque (Nm)
PP 13 - 40	40	24	45/35	M12	40
PP 50 - 75	54	30	60/50	M16	110
PP 100 - 150	54	34	60/50	M20	220

PP13-PP40 no standard plug.

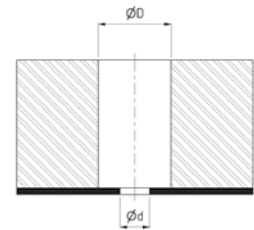

PP wear plate

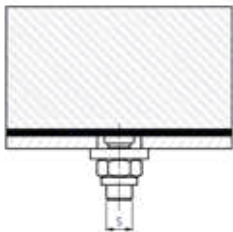

Through stud-bolt system

Trellex PP	Ød	S	Torque (Nm)
PP 13 - 40	20	M12 / UNC 1/2"	40
PP 50 - 75	24	M16 / UNC 5/8"	110
PP 100 - 150	28	M20 / UNC 3/4"	220

Only for PP13-PP40 wear plates

Plug welding system			
ØD	Ød	Plug	Weld
54	34	60/50	a2

Only for PP13-PP40 wear plates

Self-tapping screw system				
Ød	K min	S	Threading torque (Nm)	Tightening torque (Nm)
9.2	2	M10	30	55

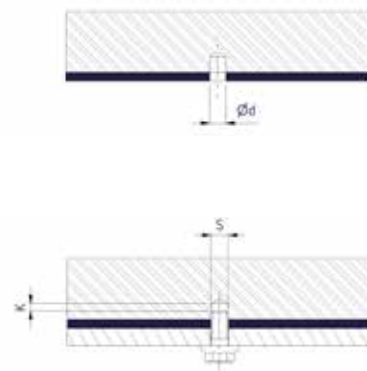
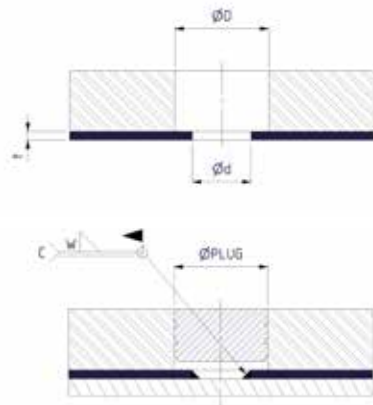

Trellex PP - Installation

Standard drilling patterns for Trellex PP

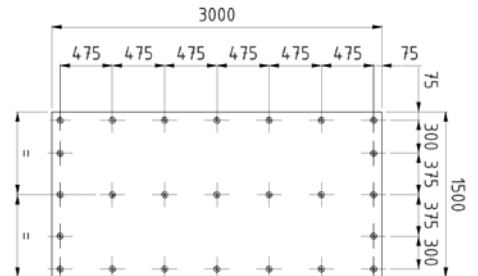
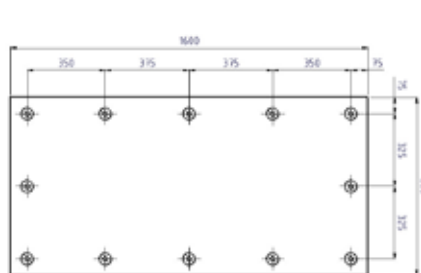
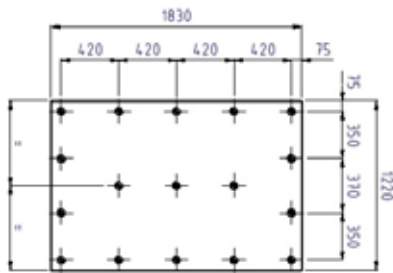
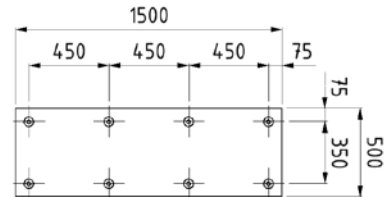
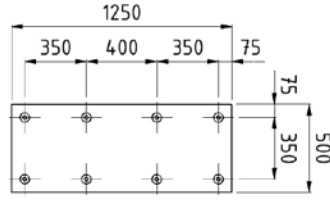
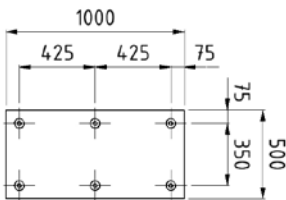
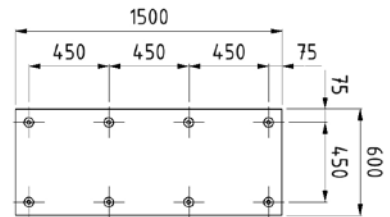
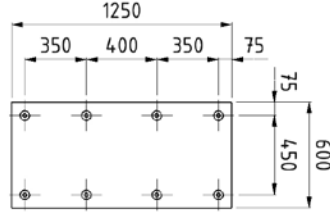
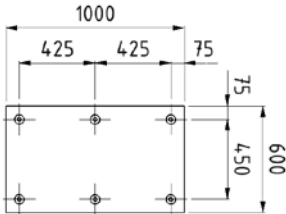
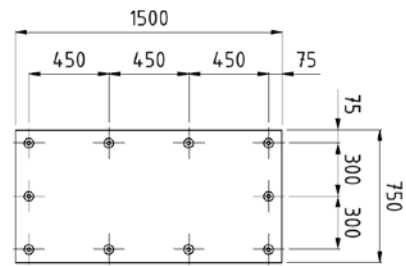
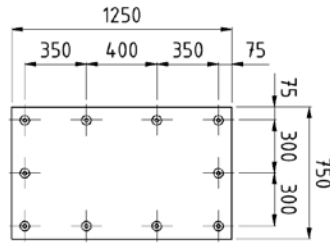
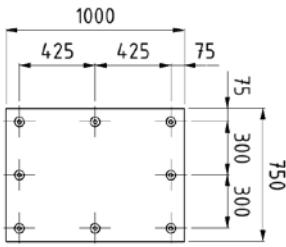

More info

Drilling pattern limits		
Measurement	Min (mm)	Max (mm)
A	50	150
B	50	500
C	50	600

If length and width >1,000 mm, additional fixing-holes (H) are required

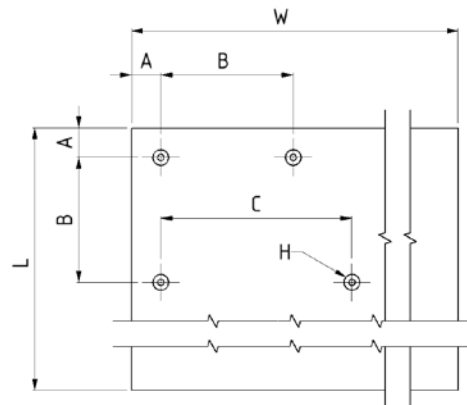

Note! All Trellex lining systems to be installed without gaps between the liners.

Trellex PP - Installation

Recommended bending radius Trellex PP

PP type	Minimum recommended bending radius (mm)	Maximum recommended bending degree (°)
- PP 23	400	0-45
PP 25 - PP 40	500	0-45
PP 50 - PP 75	600	0-45

For PP >100 mm contact Metso Outotec

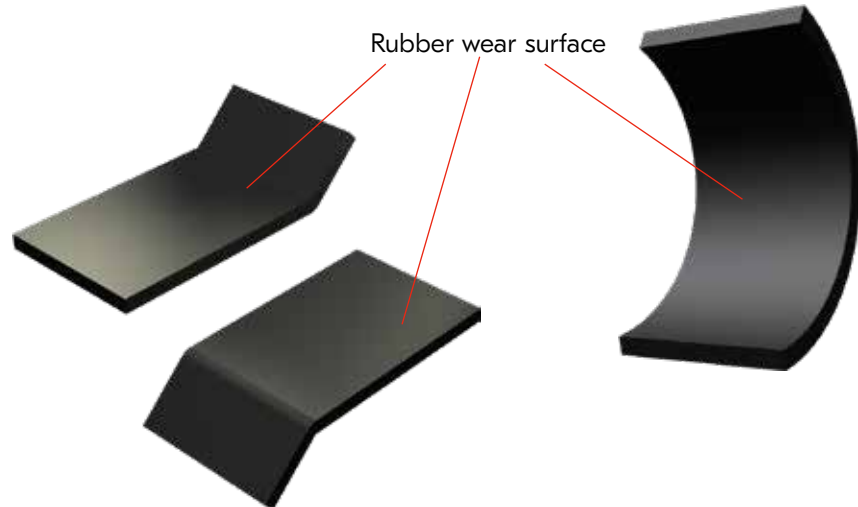

Trellex PP fixing parts

Part no.	Description	Width x Length (mm)	Weight (kg/ea)
1762100	Screw M6SF-Taptite	M10 x 20	0.014 kg
2028000	Bolt M6S	M12 x 40	0.044 kg
2028010	Bolt M6S	M12 x 50	0.055 kg
292714	Bolt M6S	M16 x 40	0.088 kg
358127	Bolt M6S	M16 x 50	0.103 kg
2887870	Bolt M6S	M20 x 50	0.179 kg
294215	Nut nyloc	M12	0.018 kg
315150	Nut nyloc	M16	0.035 kg
213587	Nut nyloc	M20	0.065 kg
6640541	Stud (welding) RB FZB incl. ceramic ring	M12 x 40	0.045 kg
2878030	Stud (welding) RB FZB incl. ceramic ring	M12 x 50	0.039 kg
602458	Stud (welding) RB FZB incl. ceramic ring	M16 x 35	0.056 kg
MM0378227	Stud (welding) RB FZB incl. ceramic ring	M16 x 40	0.064 kg
2878010	Stud (welding) RB FZB incl. ceramic ring	M16 x 50	0.090 kg
2026880	Stud (welding) RB FZB incl. ceramic ring	M20 x 40	0.008 kg
596726	Stud (welding) RB FZB incl. ceramic ring	M20 x 50	0.130 kg
00921305012S	Washer, A3	M12	0.006 kg
588970TRB	Washer 6F / Black	M16	0.016 kg
597807	Washer 8F / Black	M20	0.02 kg
212803	Washer BRB for M16	3 x 17/30	0.012 kg
352393	Washer BRB for M20	3 x 21/36	0.016 kg
T200016	Washer D45	3 x 18/45	0.030 kg
ML-248000	ML-SEALER 40/12-12	40/12-12	0.020 kg
ML-248001	ML-SEALER 40/16-12	40/16-12	0.020 kg
ML-248004	ML-SEALER 60/20-12@	60/20-12	0.030 kg
ML-217320	ML-CUPWASHER 54/40/15-14@	54/40/15-14	0.090 kg
ML-217321	ML-CUPWASHER 54/40/18-14@	54/40/18-14	0.090 kg
ML-217324	ML-CUPWASHER 80/60/22-17@	80/60/22-17	0.280 kg

Trellex PP - Installation

Trellex rubber plugs standard range

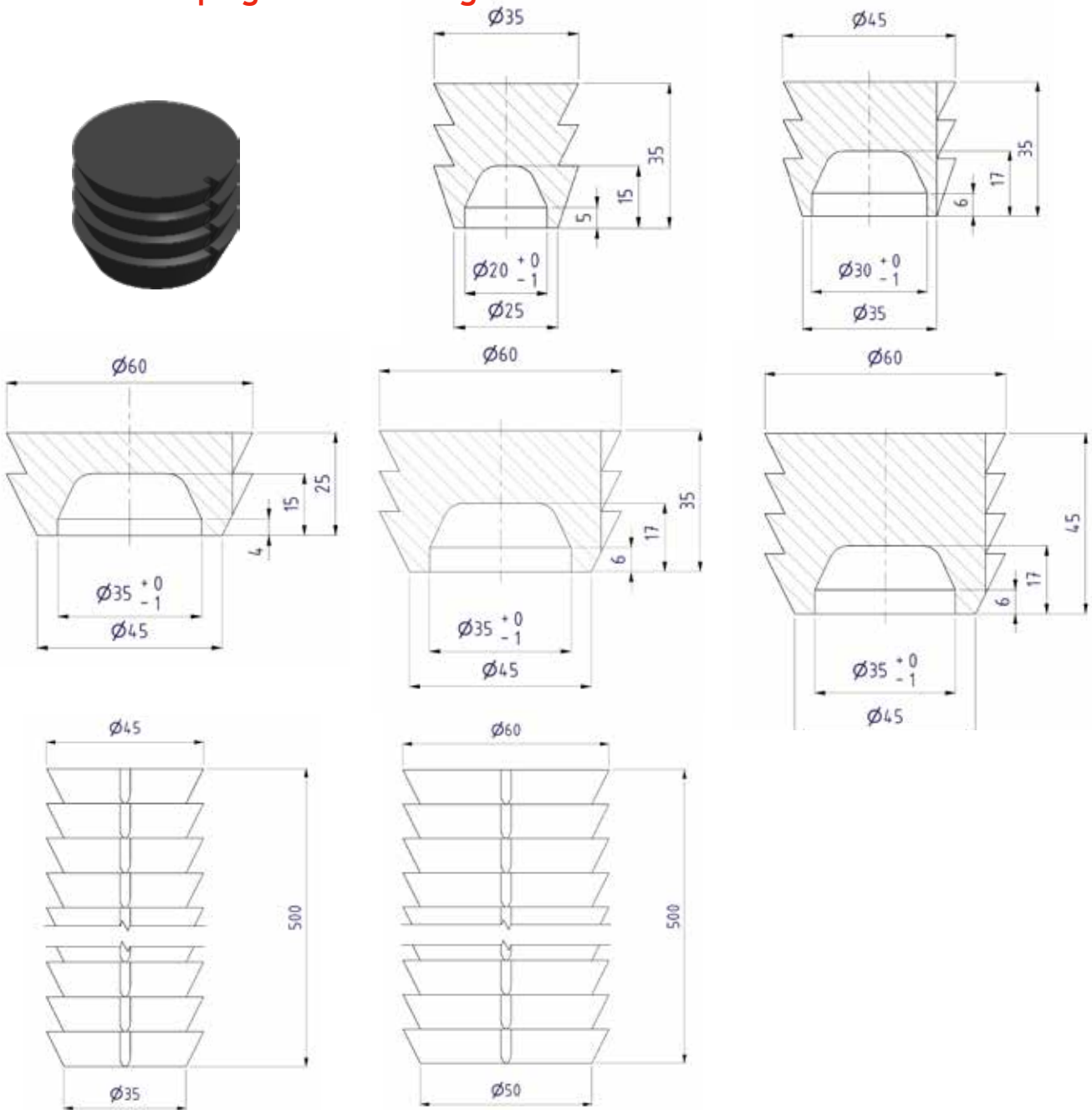

Trellex rubber plugs

Old part no.	New part no.	Size (mm)	Weight (kg/ea)
T248082	ML-248082	35/25 x 35	0.024
N/A	ML-248250	45/35 x 25	0.03
T248024	ML-248024	45/35 x 35	0.05
N/A	ML-248222	45/35 x 60	0.07
T248118	ML-248118	60/50 x 25	0.07
T248025	ML-248025	60/50 x 35	0.09
T248026	ML-248026	60/50 x 45	0.13
2328860	2328860	45/35 x 500	0.70
1826320	ML-251911	60/50 x 500	1.33

Trellex PP - General selection guide



		Sliding wear							
		Particle size							
		25	50	75	100	150	200	300	mm
		0.1	0.3	1	3	10	30	100	kg
Tonne/hrs	0-200	PP 13	PP 15	PP 20	PP 25	PP 40	PP 50	PP 75	
	200-400	PP 15	PP 20	PP 25	PP 40	PP 50	PP 75	PP 100	
	400-	PP 20	PP 25	PP 40	PP 50	PP 75	PP 100	PP 100	

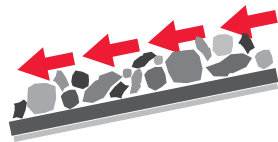

		Wear angle 0-10°							
		Particle size							
		25	50	75	100	150	200	300	mm
		0.1	0.3	1	3	10	30	100	kg
Tonne/hrs	0-200	PP 15	PP 20	PP 25	PP 40	PP 50	PP 75	PP 100	
	200-400	PP 20	PP 25	PP 40	PP 50	PP 75	PP 100	PP 100	
	400-	PP 25	PP 40	PP 50	PP 75	PP 100	PP 100	PP 100	



		Impact angle 50-90°										
		Particle size										
		25	50	75	100	150	200	300	500	700	1000	mm
		0.1	0.3	1	3	10	30	100	300	1000	3000	kg
Drop height (m)	0.5	PP 13	PP 15	PP 20	PP 25	PP 40	PP 50	PP 75	PP 75	PP 100	PP 100	
	1.0	PP 15	PP 20	PP 25	PP 40	PP 50	PP 50	PP 75	PP 75	PP 100	PP 100	
	1.5	PP 20	PP 25	PP 40	PP 40	PP 50	PP 50	PP 75	PP 75	PP 100	PP 125	
	2.0	PP 20	PP 25	PP 40	PP 50	PP 50	PP 75	PP 75	PP 100	PP 100	PP 125	
	2.5	PP 20	PP 25	PP 40	PP 50	PP 75	PP 75	PP 100	PP 100	PP 125	PP 125	
	3.0	PP 25	PP 40	PP 50	PP 50	PP 75	PP 75	PP 100	PP 100	PP 125	PP 150	

This simplified table indicates the general guidelines for selection of Trellex T60 wear rubber lining, with reference to drop height and material size. Proposed products are recommendations only.



Trellex PT

Trellex PT wear plates are manufactured from wear-resistant rubber and include hot-vulcanized aluminium fixing profiles. The Trellex PT plates have a convenient and safe fixing system with the vulcanized profile and T-bolt combination. The fixing system allow fewer fixing points than steel-reinforced wear plates.

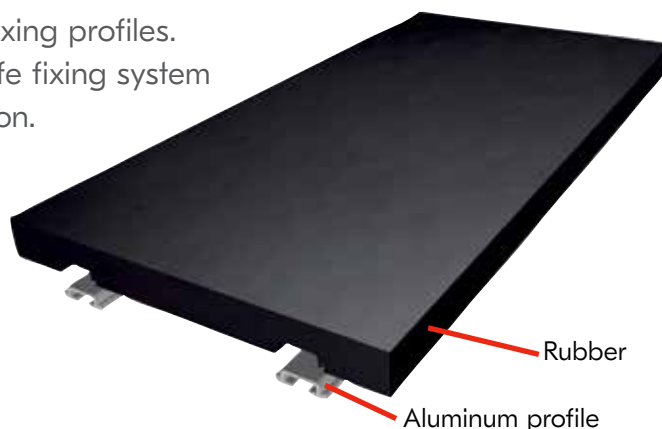

Wear elements with fixing profiles

- Integrated fixing profile
- Convenient fixing system
- High wear resistance rubber

Choice of materials

Trellex PT wear elements are manufactured from T60 wear rubber with excellent wear resistance in applications with both impact and sliding wear. Trellex PT wear plates reduce noise and vibrations and are lighter compared to other conventional steel linings. Trellex PT wear elements are available in thicknesses ranging from 50 mm to 100 mm and are manufactured in standard dimensions.

Technical description

Resists pH values 4-11 and all water types, most oils and chemicals in moderate/small concentrations.

Other information

Trellex PT is most effective in the -25° to +70°C temperature range.

Installation

Trellex PT wear plates provide excellent wear protection for feeders, bins, chutes, silos and other applications that are subject to wear and noise. For installation in applications in the medium-heavy rock and gravel industry and demanding mining and industrial applications. Trellex PT are fixed using a through-bolt system in combination with aluminum profiles and T-bolts.

Trellex PT standard range			
Part no.	Description	Width x Length (mm)	Weight (kg/ea)
680232	PT 50	500 x 1,500	48
680234	PT 50	600 x 1,500	56
680236	PT 50	750 x 1,500	69
680242	PT 75	500 x 1,500	69
680244	PT 75	600 x 1,500	81
680246	PT 75	750 x 1,500	101
680252	PT 100	500 x 1,500	90
680254	PT 100	600 x 1,500	107
680256	PT 100	750 x 1,500	132

Standard attachment details for Trellex PT

Fastening dimensions for through-bolt system			
PT type	Bolt size	T-bolt	Torque (Nm)
PT 50 and PT 75	M16	TF 35/55	190
PT 100	M20	TF 55	370



T-bolt fixing system

Trellex PT fixing parts						
Part no.	Description	A	B/C	D/E	F	Weight kg/ea
539320	TF 35/25	M12	75/65	35 x 25	6	0.11
2934400	TF 35/55	M16	100/80	55 x 35	7	0.26
2934210	TF 35/55	M16	70/50	55 x 35	7	0.22
265678	TF 55	M20	140/110	55 x 55	10	0.58
213751	TF 55	M20	110/100	55 x 55	10	0.51
213579	TF 55	M20	80/70	55 x 55	10	0.43
396135	TF 55	M20	50/40	55 x 55	10	0.36

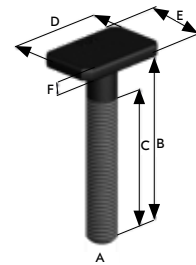
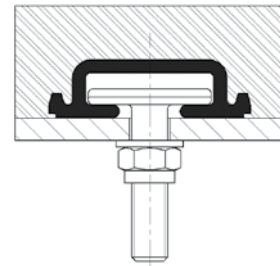

T-bolt

Standard fixing patterns for Trellex PT

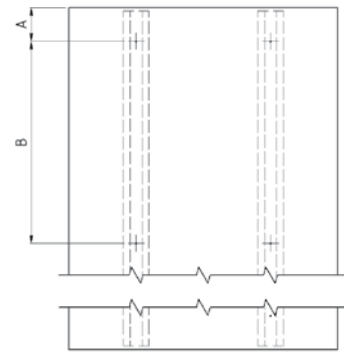
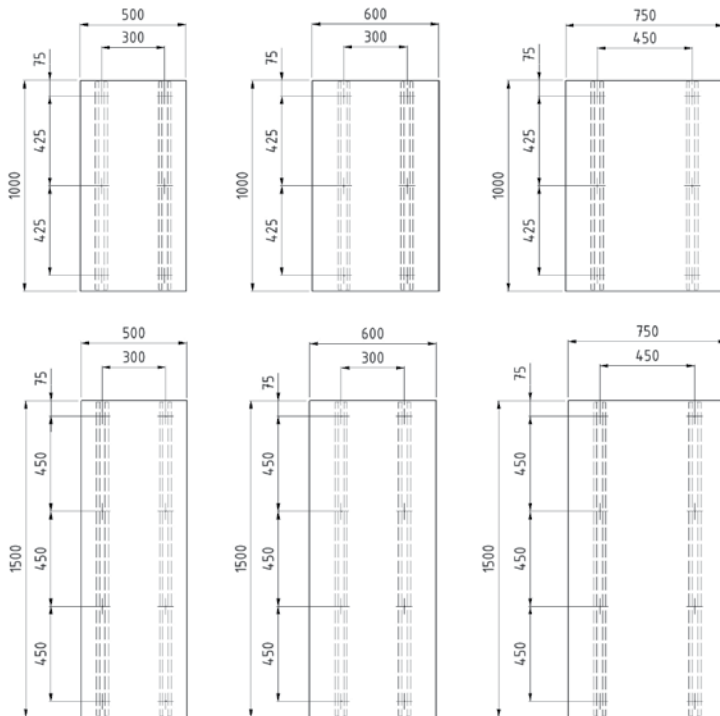

Fixing patterns limits		
Measurement	Min (mm)	Max (mm)
A	50	150
B	50	600

Other information

Standard drilling patterns for Trellex PPU, see Trellex PP.
 Fixings parts, see Trellex PP.

Note! All Trellex lining systems to be installed without gaps between the liners.

Trellex SB

Wear elements with molded fixings holes

- Integrated steel washer
- Flexible wear element
- High wear resistance rubber



Trellex SB wear plates are manufactured from wear-resistant rubber with molded holes for fixing. The fixing holes are reinforced with hot-vulcanized internal steel washers. Thanks to their design, the Trellex SB wear elements are bendable and easy to modify in terms of length and width.

Choice of materials

Trellex SB wear elements are manufactured from T60 wear rubber with excellent wear-resistance in applications with both impact and sliding wear. Trellex SB wear plates reduce noise and vibrations and are lighter compared to other conventional steel linings. Trellex SB wear elements are available in thicknesses ranging from 40 mm to 100 mm and are manufactured in standard dimensions.

Technical description

Resists pH values 4-11 and all water types, most oils and chemicals in moderate/small concentrations.

Other information

Trellex SB is most effective in the -25° to +70°C temperature range.

Installation

Trellex SB wear plates provide excellent wear protection for feeders, bins, chutes, silos and other applications that are subject to wear and noise. For installation in applications in the medium-heavy rock and gravel industry and demanding mining and industrial applications. Trellex SB plates are fixed using a through-bolt system or with stud welded bolts in combination with a proven standardized fixing pattern. To maximize the benefit of utilizing Metso Outotec liner materials, consider combining it with our range of specialized fasteners as well as the complementary lifting and handling tooling.

Trellex SB standard range			
Part no.	Description	Width x Length (mm)	Weight (kg/ea)
680421	SB 40	500 x 1,000	25
680427	SB 40	500 x 1,250	31
680422	SB 40	500 x 1,500	37
680431	SB 50	500 x 1,000	30
680432	SB 50	500 x 1,500	45
680461	SB 60	500 x 1,000	35
680467	SB 60	500 x 1,250	45
680441	SB 75	500 x 1,000	44
680447	SB 75	500 x 1,250	55
680442	SB 75	500 x 1,500	66
680451	SB 100	500 x 1,000	58
680457	SB 100	500 x 1,250	73

Min. bending radius Trellex SB	
SB type	Inner radius (mm)
SB 40-80	600
SB 100	800

For SB >100 mm contact Metso Outotec



Trellex SB fixing methods

Standard attachment details for Trellex SB

Through bolt



Through bolt

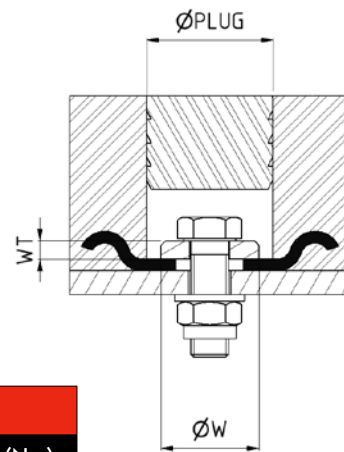
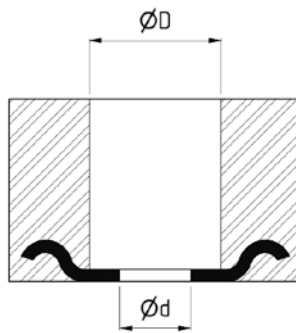

Fastening dimensions for through-bolt system

	D	d	W	W-T	Plug	Bolt size	Torque (Nm)
SB 40 - 75	54	29	Min 40	Min 6	60/50	M16	190
SB 100	54	29	Min 40	Min 6	60/50	M20	370

Stud-welded bolt



Stud-welded bolt

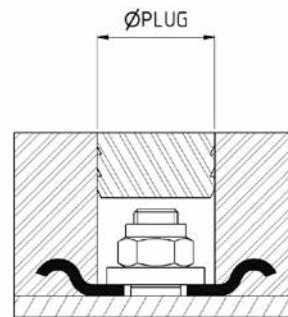
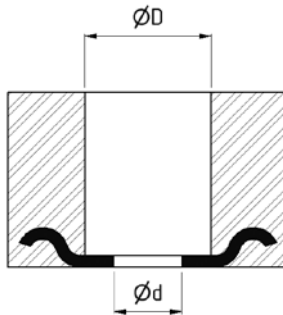

Fastening dimensions for stud-welded bolt system

	D	d	Plug	Bolt size	Torque (Nm)
SB 40 - 75	54	29	60/50	M16	110
SB 100	54	29	60/50	M20	220

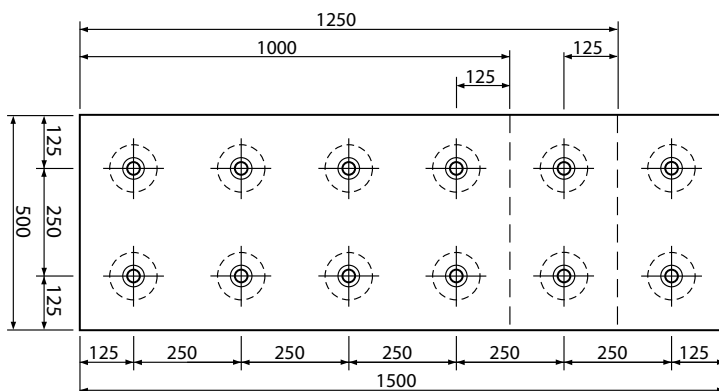

Trellex SB general selection guide

Trellex SB wear plate

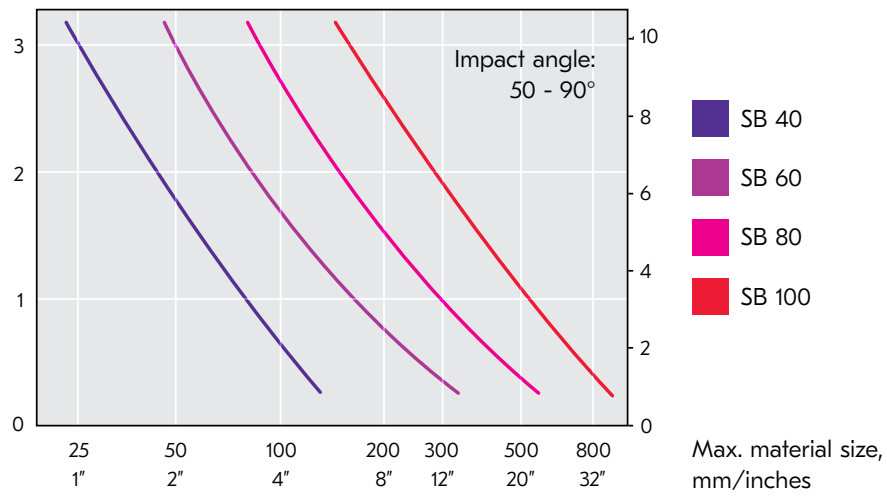

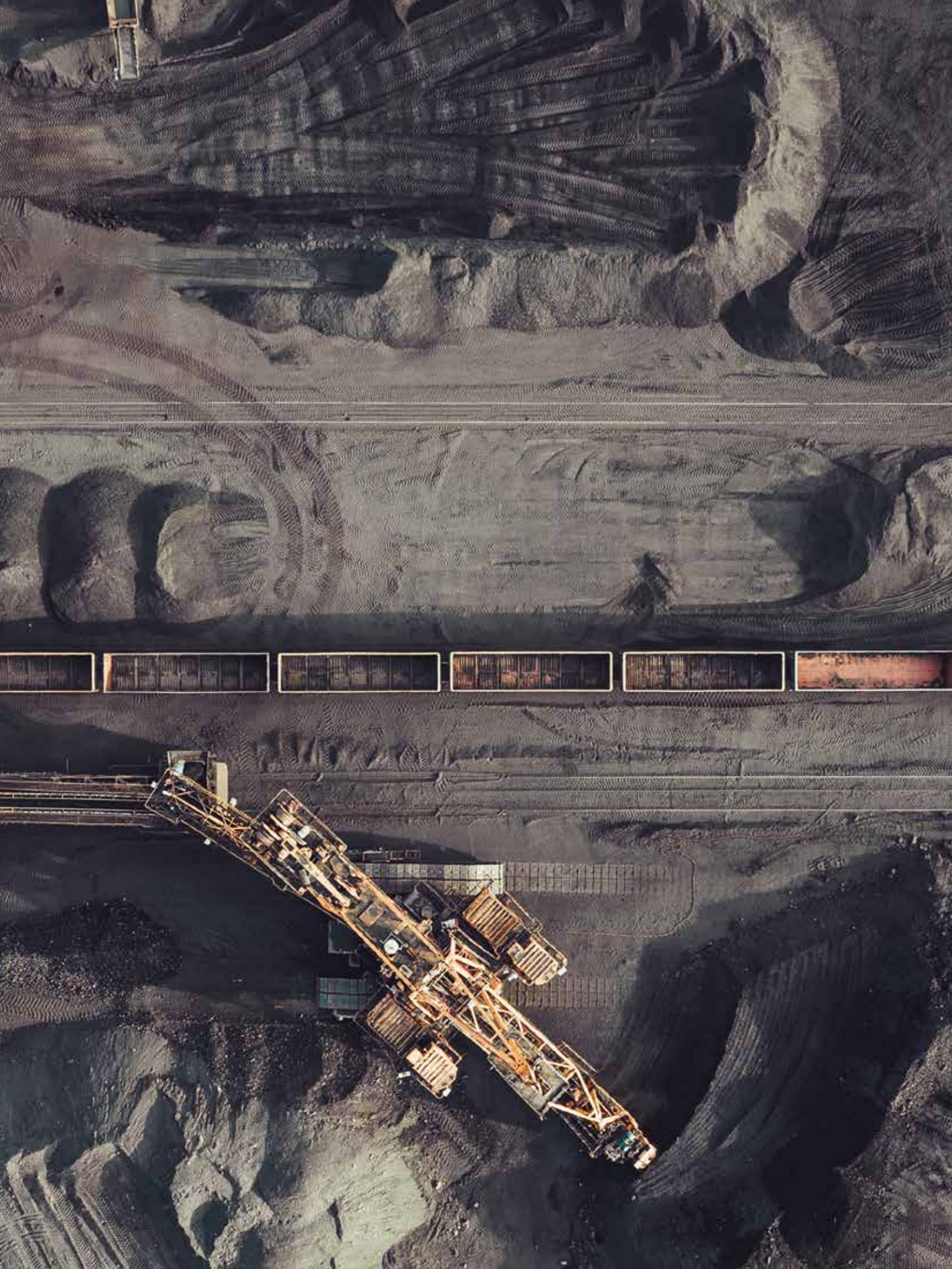

Trellex SP

Excellent wear protection with serrated surface

- Handles flow with low impact angle
- High wear-resistance rubber
- Hot-vulcanized steel reinforcement

Trellex SP wear plates are manufactured from wear-resistant rubber and have a serrated surface. The serrated surface has been designed to provide optimal life for material with impact angles between 15° and 50°. Trellex SP wear plates are reinforced with fixed hot-vulcanized steel. The steel backing guarantees secure fixing so that the wear plates remain together even if the lining is exposed to extremely abrasive and sharp particles.

Choice of materials

Trellex SP wear elements are manufactured from T60 wear rubber with excellent wear resistance in applications with both impact and sliding wear. Trellex SP wear plates reduce noise and vibrations and are lighter compared to other conventional steel linings. Trellex SP wear elements are available in thicknesses ranging from 50 mm to 125 mm and are manufactured in standard dimensions.

Technical description

Resists pH values 4-11 and all water types, most oils and chemicals in moderate/small concentrations.

Other information

Trellex WB is most effective in the -25° to +70°C temperature range.

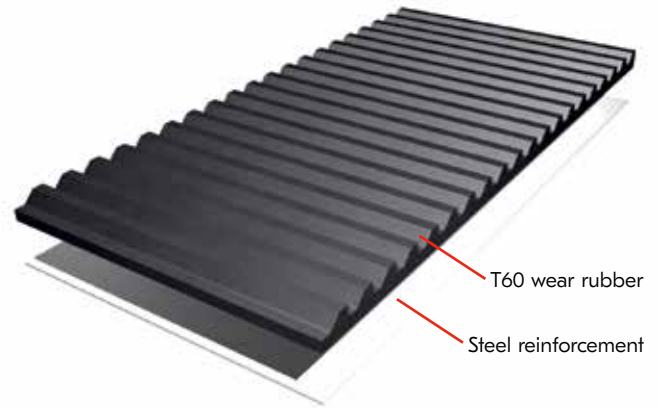

Installation

Trellex SP wear plates provide excellent wear protection for bins, chutes, silos and other applications that are subject to wear and noise. for installation in medium-heavy applications in rock and gravel industry and demanding mining and industrial applications. Trellex SP plates are fixed using a through-bolt system or with stud-welded bolts in combination with a proven fixing pattern. To maximize the benefit of utilizing Metso Outotec liner materials, consider combining it with our range of specialized fasteners as well as the complementary lifting and handling tooling.

Trellex SB standard range			
Part no.	Description	Width x Length (mm)	Weight (kg/ea)
680131	SP 50/5	500 x 1,000	38
680132	SP 50/5	500 x 1,500	57
680133	SP 50/5	600 x 1,000	46
680134	SP 50/5	600 x 1,500	69
680135	SP 50/5	750 x 1,000	57
680136	SP 50/5	750 x 1,500	86
680142	SP 75/5	500 x 1,500	70
680143	SP 75/5	600 x 1,000	56
680146	SP 75/5	750 x 1,500	105
680151	SP 100/5	500 x 1,000	59
680152	SP 100/5	500 x 1,500	81
680155	SP 100/5	750 x 1,000	81
680156	SP 100/5	750 x 1,500	121
680161	SP 125/5	500 x 1,000	63
680162	SP 125/5	500 x 1,500	95
680165	SP 125/5	750 x 1,000	94
680166	SP 125/5	750 x 1,500	143

Trellex SP fixing methods

Standard attachment details for Trellex SP

Through-bolt



Through-bolt

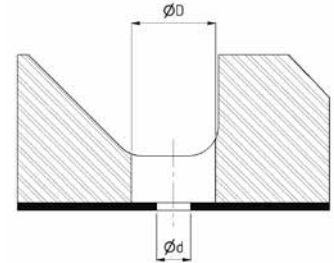
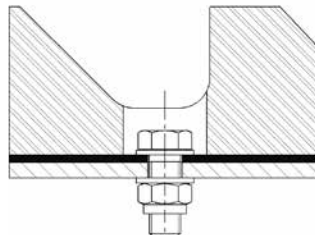

Fastening dimensions for through-bolt system

SP type	D	d	Bolt size	Torque (Nm)
SP 50 and SP 75	40	18	M16	190
SP 100 and SP 125	54	22	M20	370

Stud welded bolt



Stud-welded bolt

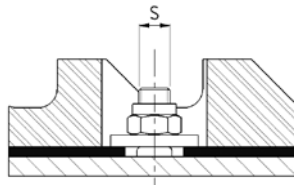

Fastening dimensions for stud-welded bolt system

SP type	D	d	Bolt size	Torque (Nm)
SP 50 and SP 75	54	30	M16	110
SP 100 and SP 125	54	34	M20	220

Drilling pattern limits

Measurements	Min (mm)	Max (mm)
A	50	150
B	50	200
C	50	600

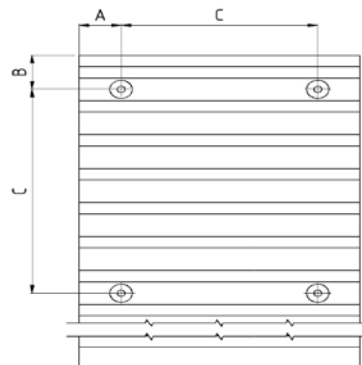

Trellex SP installation

Standard drilling patterns for Trellex SP 50

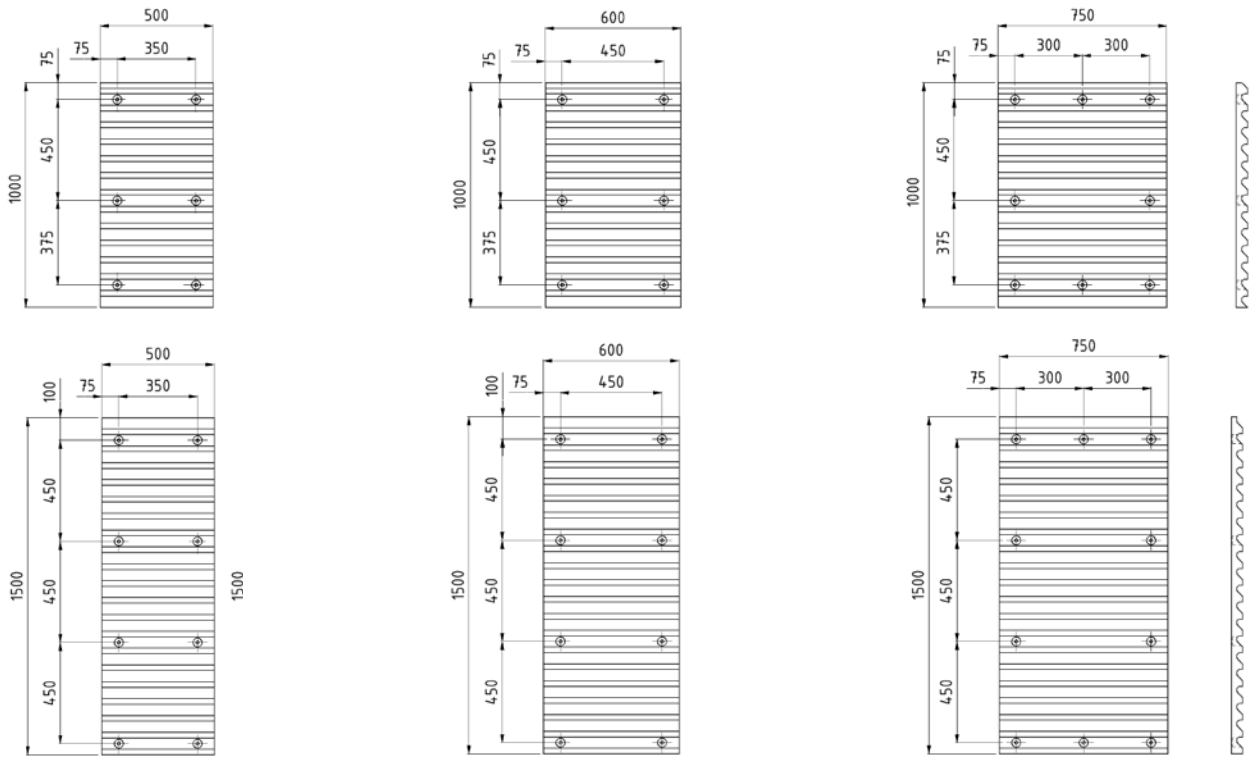

Standard drilling patterns for Trellex SP 75

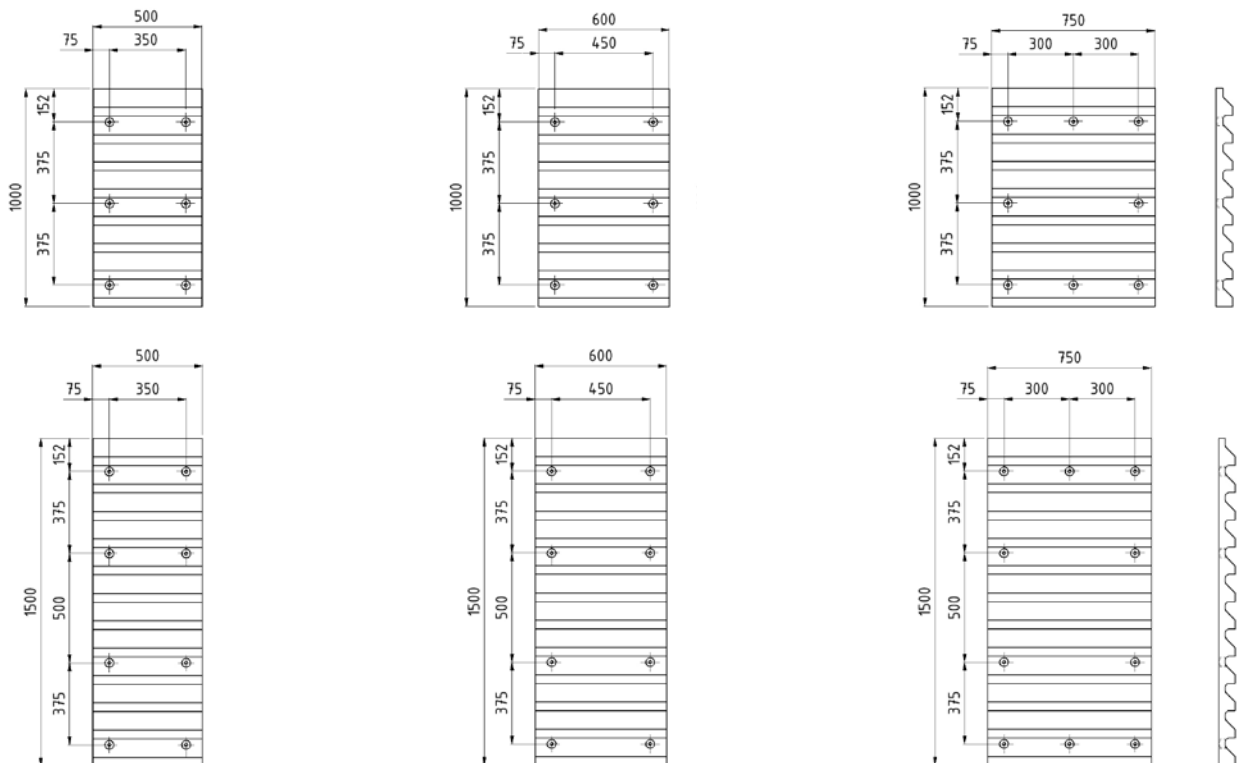

Trellex SP installation

Standard drilling patterns for Trellex SP 100

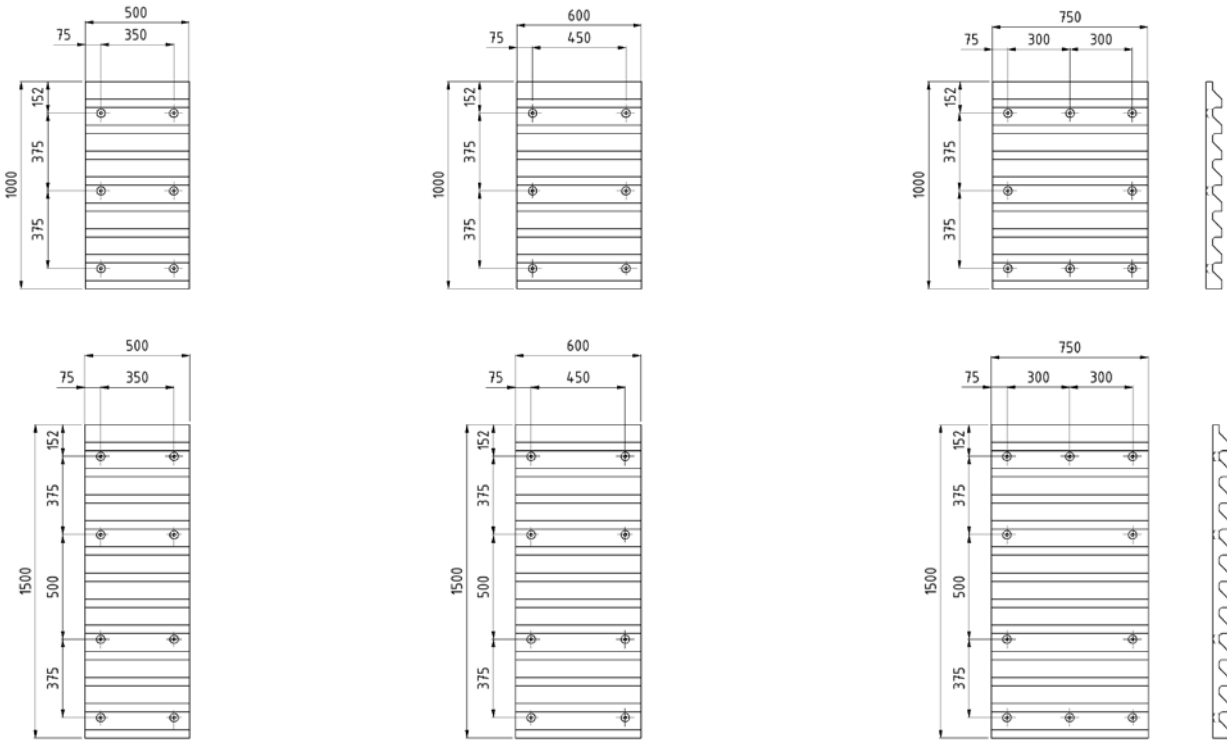

Standard drilling patterns for Trellex SP 125

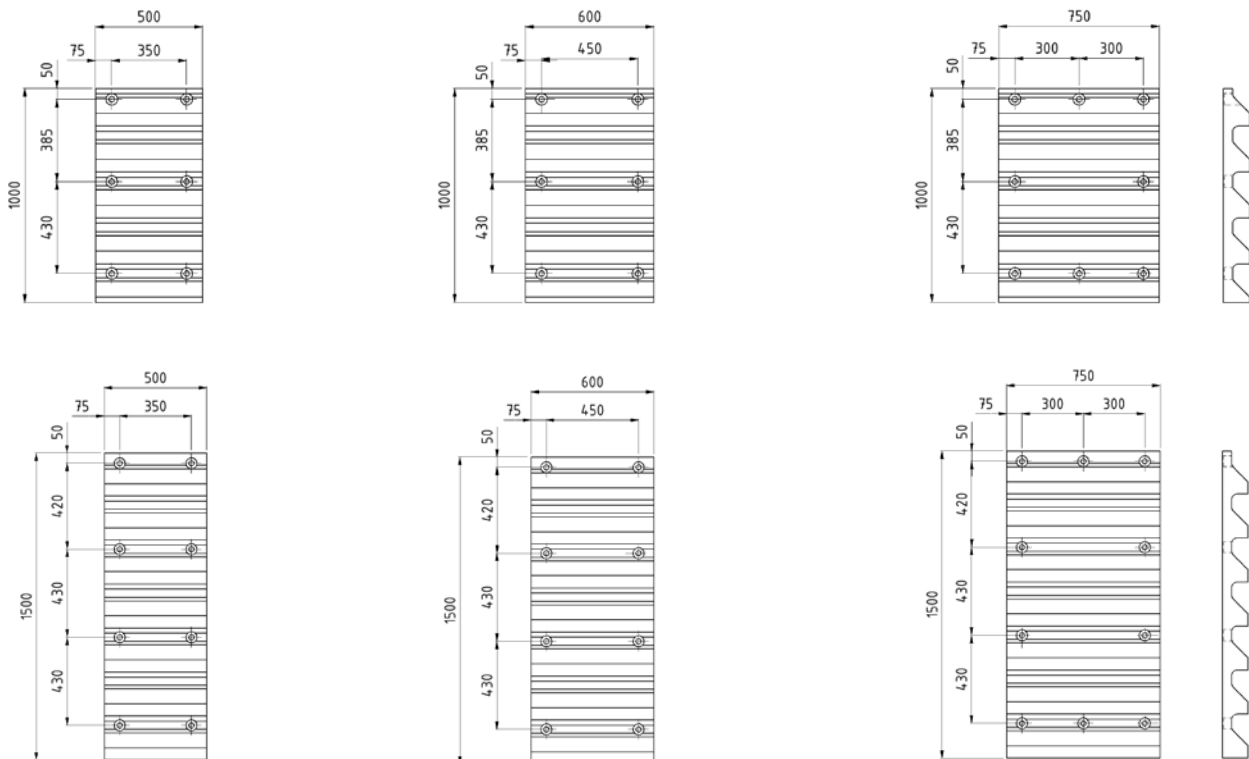

Trellex SP general selection guide



		Impact angle 10°-50°, profile element						
		Particle size						
		25 mm 0.1 kg	50 mm 0.3 kg	75 mm 1 kg	100 mm 3 kg	150 mm 10 kg	200 mm 30 kg	300 m 100 kg
Drop height	0.5 m	SFB 35	SFB 35	SP 50	SP 50	SP 50	SP 75	SP 100
	1.0 m	SFB 35	SFB 35	SP 50	SP 50	SP 75	SP 100	SP 125
	1.5 m	SFB 35	SP 50	SP 50	SP 75	SP 75	SP 100	SP 125
	2.0 m	SP 50	SP 50	SP 50	SP 75	SP 75	SP 100	SP 125
	2.5 m	SP 50	SP 50	SP 50	SP 75	SP 75	SP 100	SP 125
	3.0 m	SP 50	SP 50	SP 50	SP 75	SP 75	SP 100	SP 125

Proposed products are recommendations only.



Trellex WB

Excellent wear protection with embedded fixing profile

- High wear resistance rubber
- Handles impact and sliding wear
- Hot-vulcanized fixing profile

Trellex WB have excellent wear resistance in applications with both impact and sliding wear. Trellex WB wear bars reduce noise and vibrations and are lighter compared to conventional steel linings.



Choice of materials

Trellex WB wear bars are manufactured from T60 wear rubber and include a hot-vulcanized aluminum fixing profile. Trellex WB wear bars have a standard length of 1,500 mm and are available in heights ranging from 50 mm to 150 mm and widths from 50 mm to 150 mm. The embedded aluminum profile allows for fewer fixing points than steel-reinforced wear plates.

Technical description

Resists pH values 4-9 and all water types, also most oils and chemicals in moderate/small concentrations.

Other information

Trellex WB is most effective in the -25° to +70°C temperature range.

Installation

Trellex WB wear bars provide excellent wear protection for bins, chutes, silos and other applications that are subject to wear and noise. For installation in medium-heavy rock and gravel industry and demanding mining and industrial applications. Trellex WB wear bars are fixed by T-bolts and require 3 fixing points for lengths of 1,000 mm and 4 fixings points for lengths of 1,500 mm.

Trellex WB standard range			
Part no.	Description	Height (mm)	Weight (kg/ea)
74104	WB 50	50	4.5
74120	WB 50	75	6.6
74229	WB 75	100	13.3
74187	WB 75	50	7
74203	WB 75	75	10.2
74245	WB 100	50	9.1
74260	WB 100	75	13.4
74286	WB 100	100	17.6
74302	WB 100	125	21.9
74369	WB 125	100	21.9
74385	WB 125	125	27.2
74401	WB 125	150	32.4
74427	WB 150	100	27.2
74443	WB 150	125	33.6
74476	WB 150	150	39.9

Trellex WB fixing methods

Standard attachment details for Trellex WB

Fixing methods		
Description	Recommended T-bolt	Recommended torque (Nm)
WB 50	M12 TF 35/25	80
WB 75	M16 TF 35/55 (M12 TF 35/25)	190 (80)
WB 100	M20 TF 55 (M16 TF 35/55)	370 (190)
WB 125	M20 TF 55	370
WB 150	M20 TF 55	370

4 fixing points for standard WB length of 1,500 mm.
3 fixing points for WB length of 1,000 mm.



T-bolt fixing system

Trellex WB fixing parts						
Part no.	Description	A	B/C	D x E	F	Weight kg/ea
539320	TF 35/25	M12	75/65	35 x 25	6	0.11
2934400	TF 35/55	M16	100/80	55 x 35	7	0.26
2934210	TF 35/55	M16	70/50	55 x 35	7	0.22
265678	TF 55	M20	140/110	55 x 55	10	0.58
213751	TF 55	M20	110/100	55 x 55	10	0.51
213579	TF 55	M20	80/70	55 x 55	10	0.43
396135	TF 55	M20	50/40	55 x 55	10	0.36

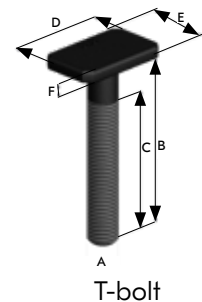

T-bolt

For other fasteners, contact Metso Outotec

Trellex Flexback

Wear lining with embedded perforated steel reinforcement

- Excellent wear resistance
- Reduces noise and vibrations
- Light wear lining



Trellex Flexback is manufactured from T60 wear rubber or polyurethane. It is hot-vulcanized or casted-in with an embedded perforated steel reinforcement.

Trellex Flexback shows excellent wear resistance in lighter and medium applications. The reinforcement makes it possible to construct self-supporting channels and chutes with simple supports of angle iron and flat iron. Flexback products reduces noise and vibrations, and is lighter compared to conventional steel linings.

Flexback provides excellent wear protection for chutes, channels, bins and other applications that are subject to wear and noise in the aggregate and mining industry, with secondary and lighter applications.

Choice of materials

- Trellex Flexback is available in rubber and polyurethane (see the PU section)
- Trellex Flexback serrated is available in rubber

Technical description:

Flexback rubber

Resists pH values between 4-11 and all water types, most oils and chemicals in moderate/small concentrations.

Other information

Trellex Flexback products are most effective in the -25° to +70°C temperature range.

Trellex Flexback RU standard range			
Part no.	Description	Width x Length (mm)	Weight (kg/ea)
1442540	FB 10	1,270 x 3,000	63
1442550	FB 15	1,270 x 3,000	84
1442560	FB 20	1,270 x 3,000	105
1442570	FB 25	1,270 x 3,000	127
1442900	FB 30	1,270 x 3,000	148

Trellex Flexback serrated

Serrated wear lining with embedded perforated steel reinforcement

- Excellent wear resistance
- Optimized for low impact angles
- Reduces noise and vibrations
- Light wear lining



Trellex Flexback serrated is manufactured from T60 wear rubber and is hot-vulcanized with an embedded, perforated steel reinforcement and is optimized for handling material impacting at angles between 15° and 50°.

Technical description:

Flexback serrated

Resists pH values 4-11 and all water types, most oils and chemicals in moderate/small concentrations.

Other information

Trellex Flexback products are most effective in the -25° to +70°C temperature range.

Trellex Flexback serrated standard range			
Part no.	Description	Width x Length (mm)	Weight (kg/ea)
2929110	FBS 35	1,270 x 3,000	119



Trellex Flexback fixing methods

Standard attachment system

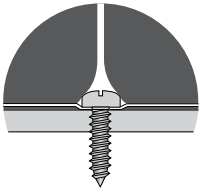

Self-tapping screw

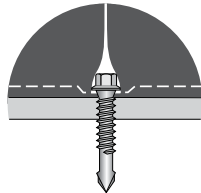

Drill & self-tapping screw

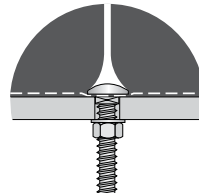

Carriage bolt

Customized fastening pattern limits		
Measurements	Min (mm)	Max (mm)
A	20	50
B	50	200*
C	50	600

*For Flexback serrated 236 mm

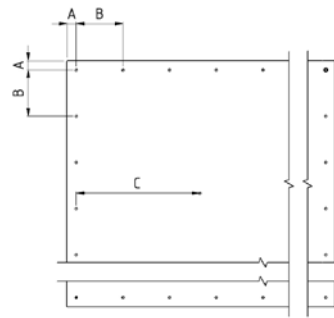

Standard fastening pattern Flexback RU

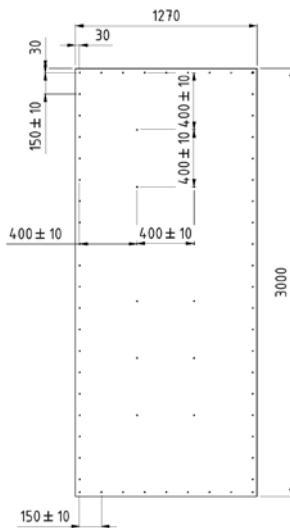

Standard fastening pattern Flexback serrated

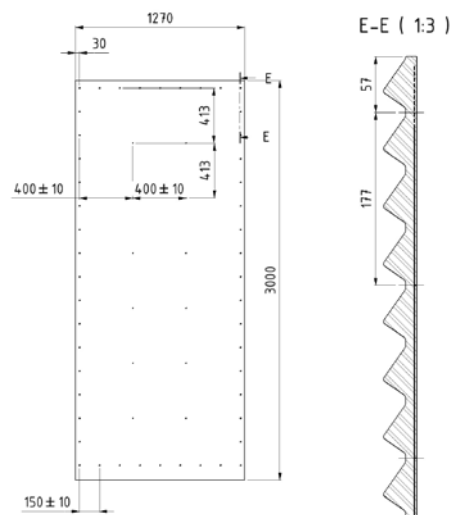

Trellex Flexback selection guide

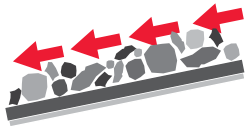

		Trellex Flexback RU - Wear angle 10°-50°						
		Particle size						
		25 mm	50 mm	75 mm	100 mm	150 mm	200 mm	300 mm
		0.1 kg	0.3 kg	1 kg	3 kg	10 kg	30 kg	100 kg
Drop height	0-200	FB 15	FB 20	FB 25	FB 30	N/A	N/A	N/A
	200-400	FB 20	FB 25	FB 30	N/A	N/A	N/A	N/A
	400-	FB 25	FB 30	N/A	N/A	N/A	N/A	N/A



		Trellex Flexback RU						
		Particle size						
		25 mm	50 mm	75 mm	100 mm	150 mm	200 mm	300 mm
		0.1 kg	0.3 kg	1 kg	3 kg	10 kg	30 kg	100 kg
Drop height	0-200	FBU 10	FBU 15	FBU 25	FBU 30	See Trellex PP guide		
	200-400	FBU 15	FBU 20	FBU 30				
	400-	FBU 20	FBU 25					

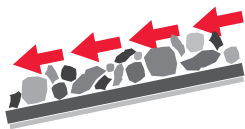

		Trellex Flexback PU - Wear angle 10°-50° - moisture/wet conditions						
		Particle size						
		25 mm	50 mm	75 mm	100 mm	150 mm	200 mm	300 mm
		0.1 kg	0.3 kg	1 kg	3 kg	10 kg	30 kg	100 kg
Drop height	0-200	FBU 10	FBU 15	FBU 25	FBU 30	N/A	N/A	N/A
	200-400	FBU 15	FBU 20	FBU 30	N/A	N/A	N/A	N/A
	400-	FBU 20	FBU 25	N/A	N/A	N/A	N/A	N/A



		Trellex Flexback serrated - Impact angle 10°-50°						
		Particle size						
		25 mm	50 mm	75 mm	100 mm	150 mm	200 mm	300 mm
		0.1 kg	0.3 kg	1 kg	3 kg	10 kg	30 kg	100 kg
Drop height	0-200	FBU 10	FBU 15	FBU 25	FBU 30	See Trellex SP guide		
	200-400	FBU 15	FBU 20	FBU 30				
	400-	FBU 20	FBU 25					

Proposed products are recommendations only.

Trellex SQ 300

Fully recyclable modular system for wear protection

- Reduced noise - protects workers' hearing
- Modular system - means lighter work
- Cutting - reduces emissions
- No welding - minimize risks
- PAH-free - eliminates cancer concerns



At last, the mining and construction industry has access to a modern, environmentally friendly wear protection system that reduces impacts and improves health and safety in a variety of important ways — all without increasing costs or sacrificing operational efficiency. Suitable for use in chutes, transfer points and other areas subject to wear, Trellex SQ 300 provides excellent protection in many applications, keeping material flow up and maintenance time down.

Choice of materials

Trellex SQ 300 elements have the outer dimension 300x300 mm and are available in three different materials: rubber, polyurethane or ceramic (not recyclable).

Technical description

The modular system can handle particle sizes up to 200 mm (8"). Resists pH values 4-9 and all water types, and most oils and chemicals in moderate/small concentrations.

Other information

Trellex SQ 300 is most effective in the -25° to +70°C temperature range.

Installation

Trellex SQ 300 has been designed for simplicity of installation and minimum downtime using a patented fastening system. Installation is easy when following the guidelines provided in each box. Rubber and polyurethane are easy to cut with a knife or an Alu-Cut machine.

Trellex SQ 300 module standard range		
Description	Material	Fixing
SQ 300 CE 40	Ceramic & PU	2 part spider + CE plug
SQ 300 PU 30	PU 70°	Spider plug
SQ 300 PU 40	PU 80°	Spider + PU plug
SQ 300 RU 30	Rubber T-60	Spider plug
SQ 300 RU 40	Rubber T-60	Spider + PU plug
SQ 300 RU 50	Rubber T-60	Spider + PU plug
SQ 300 RU 60	Rubber T-60	Spider + PU plug
SQ 300 RU 75	Rubber T-60	Spider + PU plug

All modules are 300x300 mm.

Trellex SQ 300 standard range box			
Part no.	Description	Weight (kg/ea)	Elements/box
660343	SQ 300 Box CE 40	521	66
6660551	SQ 300 Box PU 30	215	66
6660274	SQ 300 Box PU 40	283	66
6660550	SQ 300 Box RU 30	209	66
660340	SQ 300 Box RU 40	293	66
660350	SQ 300 Box RU 50	364	66
MM0371984	SQ 300 BOX RU 60	302	45
MM0371985	SQ 300 BOX RU 75	375	45

Details of items included

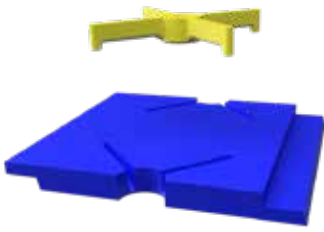

Trellex SQ 300 PU 30 mm/1.18"	
Part no.	Description
660327	SQ PU 30 Module
6650296	Spider plug

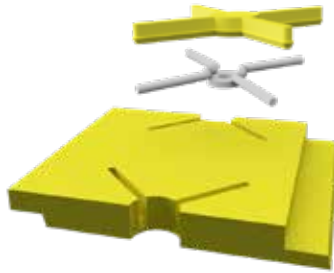

Trellex SQ 300 PU 40 mm/1.58"	
Part no.	Description
660328	SQ PU 40 Module
660329	Spider
660325	PU-PLUG 40

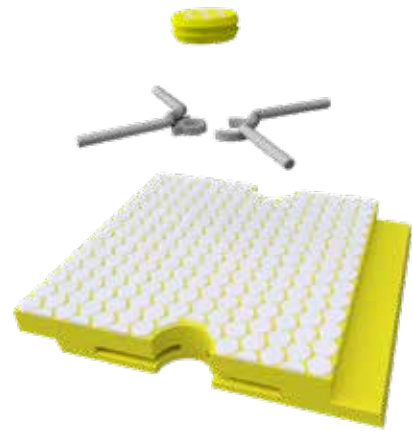

Trellex SQ 300 CE 40 mm/1.58"	
Part no.	Description
660324	SQ CE 40 Module
660330	Spider (2 parts)
660325-CE	PLUG-CE 40
2931830	Washer

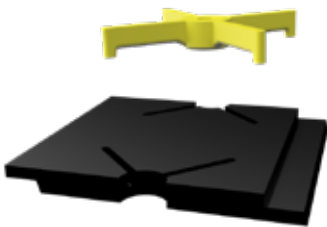

Trellex SQ 300 RU 30 mm/1.18"	
Part no.	Description
6660224	SQ RU 30 Module
6650296	Spider plug

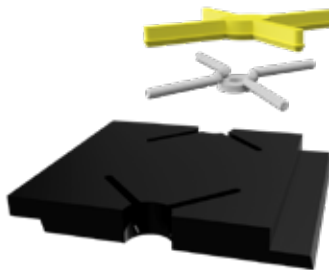

Trellex SQ 300 RU 40 mm/1.58"	
Part no.	Description
660399	SQ RU 40 Module
660329	Spider
660325	PU-PLUG 40

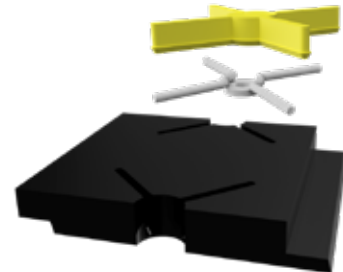

Trellex SQ 300 RU 50 mm/2"	
Part no.	Description
660398	SQ RU 50 Module
660329	Spider
660326	PU-PLUG 50 MM

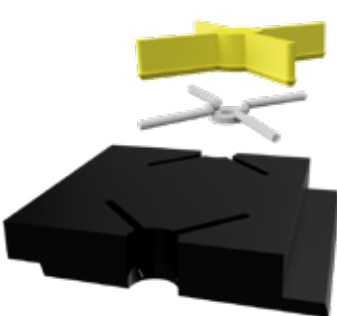

Trellex SQ 300 RU 60 mm/2.36"	
Part no.	Description
MM0371429	SQ RU 60 Module
660329	Spider
MM0371430	PU-PLUG 60

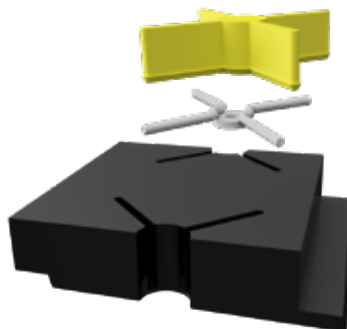

Trellex SQ 300 RU 75 mm/2.86"	
Part no.	Description
MM0371431	SQ RU 75 Module
660329	Spider
MM0371433	PU-PLUG 75



Trellex SQ 300 box contains 66 pieces of modules, plugs, spiders. One box covers a lining area of approx. 6 m²

Trellex SQ 300 fixing methods

Through bolt	
Bolt size	Recommended torque (Nm)
M12	80
M16	190

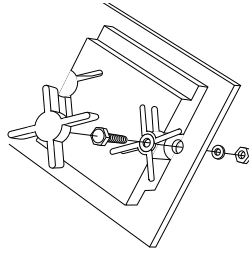

Rubber/PU 40 and 50

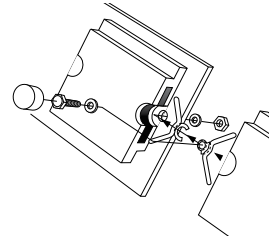

Ceramic CE 40

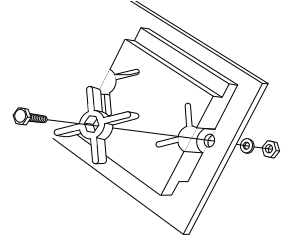

Rubber/PU 30

Stud-welded bolt	
Bolt size	Recommended torque (Nm)
M12	40
M16	110

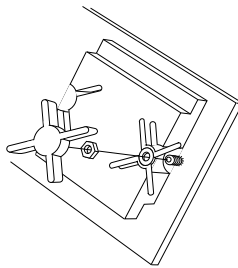

Rubber/PU 40 and 50

Cutting limits		
Measurement	Min (mm)	Max (mm)
A	90	200

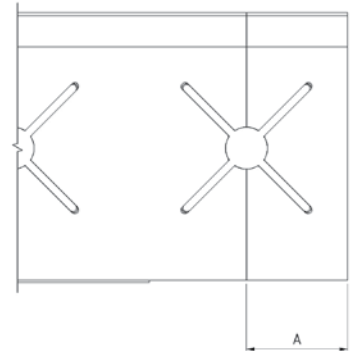
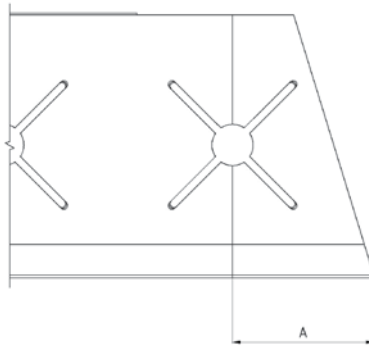

Trellex SQ 300 selection guide

SQ 300 ceramic guide

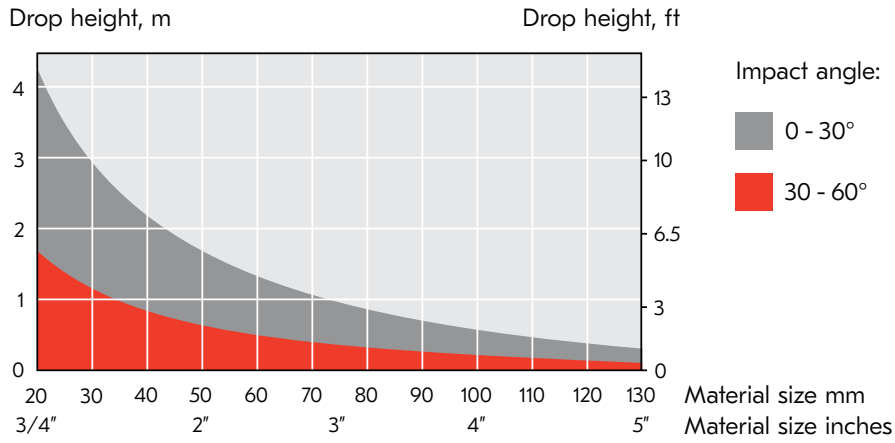

SQ 300 rubber guide

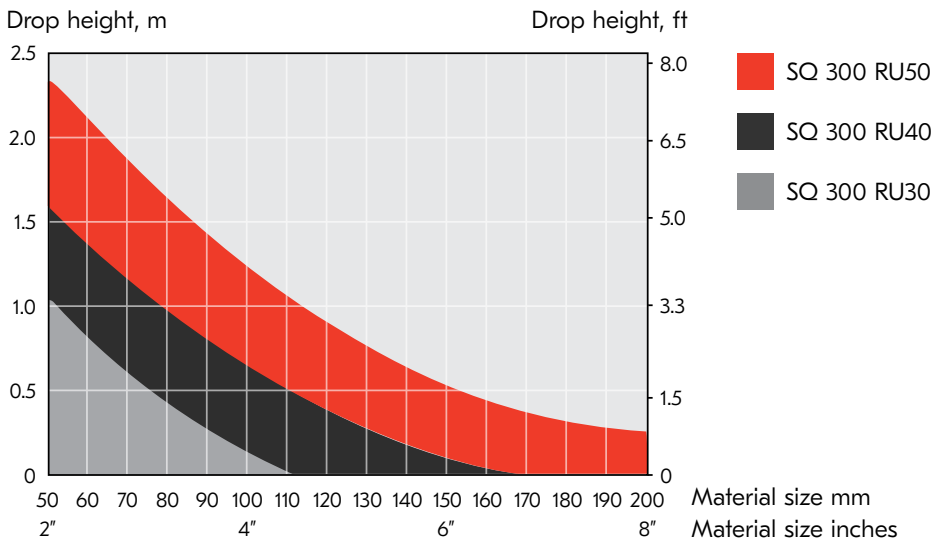

Microledge™



Microledge™

Microledge is the “drop in” solution for hoppers and chutes handling fines and wet and sticky product. The Microledge rubber ledges flex as material makes contact, releasing material and preventing excessive material build up, in effect “self-cleaning”. A customized Microledge solution is developed by Metso Outotec for each application based on a common modular design, utilizing standard parts kept in stock. The simple fastening system attaches to the top of the chute or hopper for ease of installation, incorporating lifting lugs for a safe and simple installation and removal process.

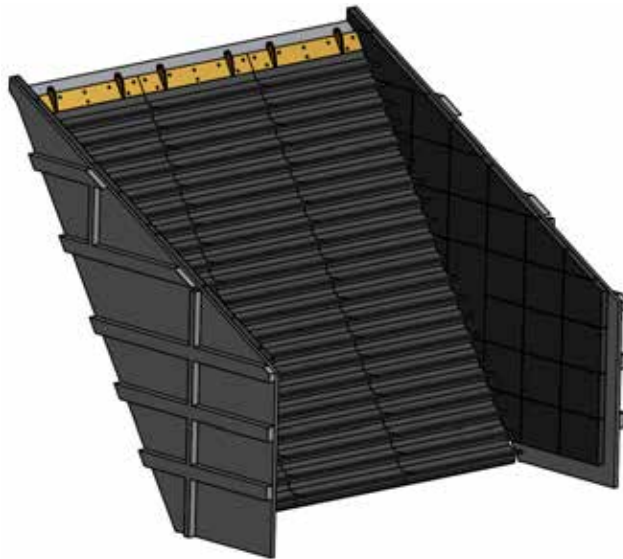

Designed by Metso Outotec to fit your needs

Self-cleaning properties help to substantially reduce the build-up of fines that cause blockages and hang ups in chutes and hoppers. The curtains can handle the build-up of wet and sticky product and will ultimately self-clean through product to product contact.

As feed hits the flexible cleats, they flex and the surface remains dynamic to reduce the material that can build up. If material does build up, depending on the moisture content, the weight of the product creates movement within the cleats and dislodges.

The simple and safe installation process generates major savings in operational interruptions by reducing chute liner installation shutdown periods and reducing or eliminating dedicated chute cleaning downtime.

Ease of installation with safety in mind

Microledge curtains include an effective and combined curtain lifting and attachment system, which allows for quick installation and removal and removes the need for scaffolding and confined space intrusion into each chute, a major safety benefit.

The lifting and attachment system incorporates certified lifting points to allow simple and safe installation and replacement and is designed so that the curtain is attached and fastened at the top of the chute or hopper. The concept design by Metso Outotec provides major benefits by reducing the operational shutdown windows and resources required for the installation or replacement of the Microledge curtain.



Polyurethane and Polyethylene wear lining

Polyurethane and polyethylene wear lining

Metso Outotec Polyurethane wear lining is made of high-temperature castable polyurethane elastomers and guarantees the best possible wear resistance in the most demanding applications. Polyurethanes are also very flexible, resulting in a superior durability for a wide range of applications.

Metso Outotec Polyethylene wear lining is manufactured from ultra-high molecular weight polyethylene (PE-UHMW) for installation in light-duty applications with clogging problems and sticky materials. The main characteristic of polyethylene is its low surface friction.

Wear-life improvement

Improve the wear life of your equipment by protecting it with polyurethane and polyethylene wear plates – for wet or dry applications, small to medium material sizes and different impact angles. All elements to achieve the maximal lifetime and production capacity.

Flow improvement

Improve poor material flow caused by narrow sectors in the process. Such spots can be real bottlenecks and create a lot of additional work and unplanned downtime.

Noise reduction

Excessive noise is a problem in mining and aggregate operations. Managing noise pollution is more important than ever. All Trellex polyurethane and polyethylene wear products reduce noise and thereby contribute to a better work environment.

Polyurethane and polyethylene wear lining

The excellent abrasion resistance and toughness of polyurethane will outperform other materials like steel, plastic and rubber in demanding applications where sliding wear peaks, such as the discharge ends of feeders and screens etc.

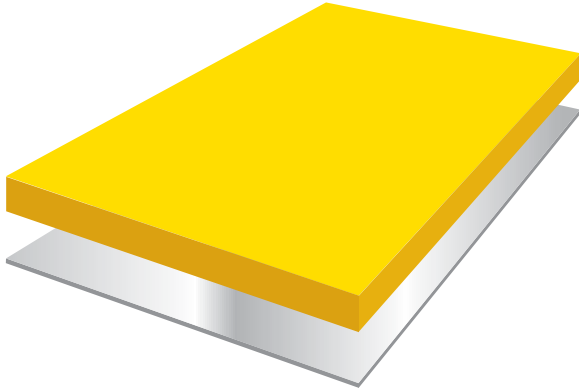

Trellex PPU

Wear plates made of polyurethane and backed with a cast-in steel reinforcement. Excellent wear resistance in applications with sliding wear. The steel reinforcement prevents the possibility of small particles getting under the lining. The steel reinforcement also guarantees secure fixing so that the wear plates remain together even if the lining is exposed to extremely abrasive and sharp particles.

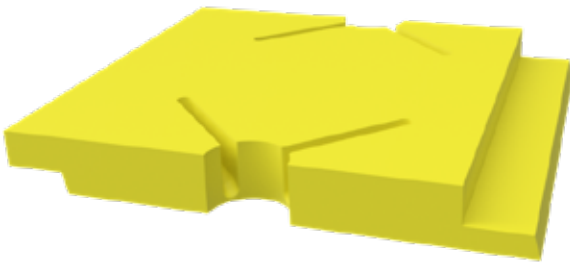

Trellex SQ 300 polyurethane

A modern, environmentally friendly wear protection system that reduces impacts and improves health and safety without increasing costs or sacrificing operational efficiency. Trellex SQ 300 is designed for simplicity of installation and minimum downtime, using the patented fastening system. It's easily cut to the right size using a knife or an Alu-Cut machine.



Trellex LF

Made of an ultra-high molecular weight polyethylene that minimizes surface friction to prevent material sticking, Trellex LF plates are excellent for low wear applications that have flow problems with sticky materials and for light-duty applications with clogging issues and sticky materials.



Trellex Flexback

Excellent wear resistance in lighter and medium applications. The reinforcement makes it possible to construct self-supporting channels and chutes with simple supports of angle iron and flat iron and provides excellent wear protection for chutes, channels, bins and other applications that are subject to wear and noise.

Trellex PPU

Trellex PPU wear plates are made of polyurethane and are reinforced with an embedded steel plate.

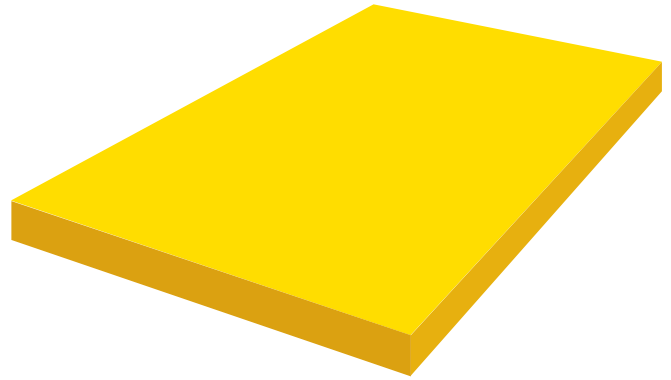

Wear elements made of polyurethane

- Wear-resisting polyurethane
- Steel reinforced
- Resists most chemicals

Excellent wear resistance in any applications with sliding wear. The steel reinforcement prevents the risk of small particles getting under the lining. The steel reinforcement also guarantees secure fixing so that the wear plates remain together even if the lining is exposed to extremely abrasive and sharp particles. In addition, Trellex PPU wear plates reduce noise and vibrations and are lighter than conventional steel linings.

Choice of materials

Trellex PPU wear elements are manufactured from polyurethane with excellent wear resistance in applications with sliding wear. Trellex PPU wear elements are available in thicknesses ranging from 10 mm to 20 mm and are manufactured in standard dimensions. The wear elements are manufactured with a standard hardness of 80 sH(A) (yellow). Also available as alternatives in hardnesses of 70 sH(A) (blue) and 90 sH(A) (green).

Technical description

Resists pH values 4-9 but is not designed for underwater applications. Resists attack from most oils and chemicals and environments exposed to ozone.

Other information

Trellex PPU is most effective in the -20° to +70°C temperature range.

Installation

Trellex PPU wear plates provide excellent wear protection for feeders, bins, chutes, silos, and other applications that are subject to sliding wear and noise. For installation in light to medium applications in the aggregate and mining industries. Trellex PPU can be installed in several different ways, using a through-bolt system, stud-welded bolts, self-tapping screw or plug welded.

To maximize the benefit of utilizing Metso Outotec liner materials, consider combining it with our range of specialized fasteners as well as the complementary lifting and handling tooling.

Trellex PPU standard range			
Part no.	Description	Width x Length (mm)	Weight (kg/ea)
690110-80	PPU 10/3	1,000 x 2,000	62
690115-80	PPU 15 /3	1,000 x 2,000	74
690120-80	PPU 20/3	1,000 x 2,000	86

Custom-made dimensions upon request.

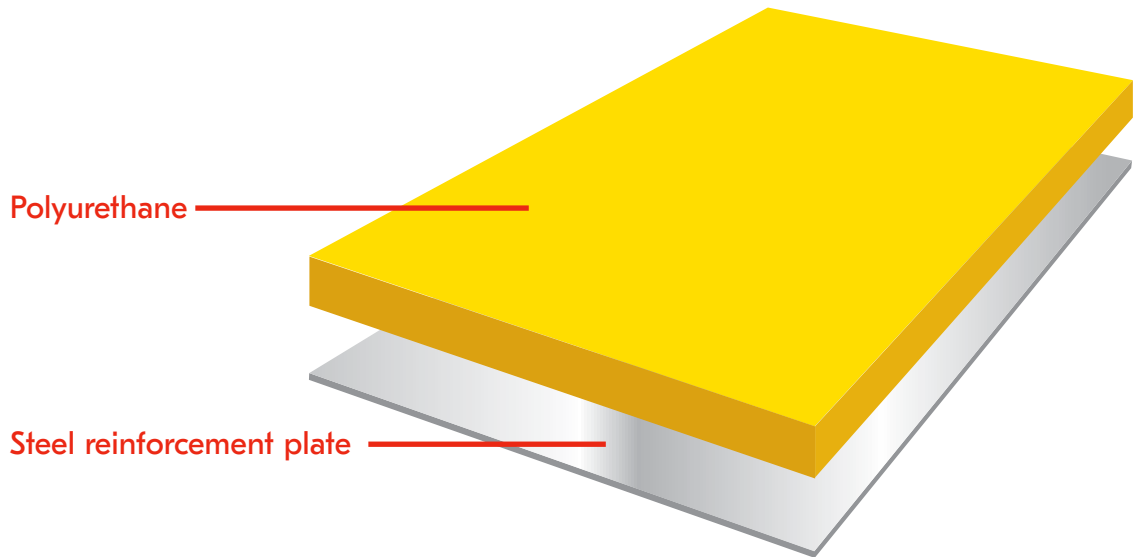

Trellex PPU fixing methods

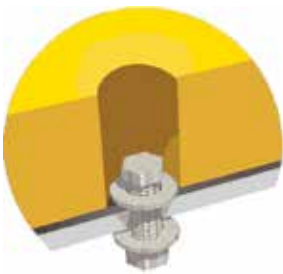

Through bolt



Stud-welded bolt



Plug welded



Self-tapping screw

Other information

Standard drilling patterns for Trellex PPU, see Trellex PP.

Fixings parts, see Trellex PP.

Note! All Trellex lining systems to be installed without gaps between the liners.

Trellex LF

Excellent for applications that require extremely low friction

- Ultra-high molecular weight polyethylene
- Low friction
- Minimizes clogging

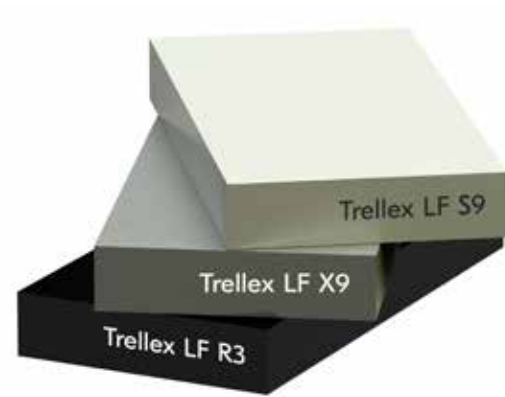

Trellex LF elements are made of an ultra-high molecular weight polyethylene that minimizes surface friction to prevent material sticking. An excellent solution for bins, chutes, silos and other low wear applications that have flow problems with sticky materials. Suitable for light-duty applications with clogging problems.

Choice of materials

Trellex LF is available in three different qualities:

- LF R3 - Good wear and sliding properties
- LF S9 - High resistance to wear and low coefficient of sliding friction
- LF X9 - High resistance to wear and extremely low coefficient of sliding friction
High resistance to temperature

Technical description

Resists most pH values and water types, and most chemicals in moderate concentrations.

Other information

Trellex LF is effective in the -60° to $+70^{\circ}\text{C}$ temperature range.

Installation

LF elements are delivered in standard dimension. The elements can easily be adapted to the final dimension requirement and drilled on site; a reliable through-bolt fixing system secures the installation.



Trellex LF standard range

Part no.	Description	Thickness x width x length (mm)	Weight (kg/ea)
1520100	Trellex LF R3	6 x 1,220 x 3,015	28
1520110	Trellex LF R3	10 x 1,250 x 3,050	35
1520120	Trellex LF R3	15 x 1,250 x 3,050	53
1520562	Trellex LF R3	20 x 1,250 x 3,050	71
1520130	Trellex LF R3	25 x 1,250 x 3,050	88
6660532	Trellex LF R3	30 x 1,250 x 3,050	106
1520564	Trellex LF R3	40 x 1,250 x 3,050	145
1520140	Trellex LF S9	6 x 1,220 x 3,015	28
1520150	Trellex LF S9	10 x 1,250 x 3,050	35
1520160	Trellex LF S9	15 x 1,250 x 3,050	52
1624520	Trellex LF S9	20 x 1,250 x 3,050	70
1520170	Trellex LF S9	25 x 1,250 x 3,050	87
6628030	Trellex LF S9	30 x 1,250 x 3,050	101
1520556	Trellex LF S9	40 x 1,250 x 3,050	145
1520565	Trellex LF X9	6 x 1,000 x 3,000	22
1520567	Trellex LF X9	10 x 1,220 x 3,050	35
1520569	Trellex LF X9	15 x 1,220 x 3,050	52
1520570	Trellex LF X9	20 x 1,220 x 3,050	70
1520583	Trellex LF X9	30 x 1,250 x 3,000	105

Other qualities and dimensions on request.

	Properties	Unit	Trellex LF X9	Trellex LF S9	Trellex LF R3	Test method
General properties	Color		Grey	White	Black	
	Density	g/cm ³	0,93	0.94	0.94	ISO 1183
	Molecular weight	g/mol	>9x10 ⁶	9x10 ⁶	-	
	Water absorption	%	<0.01	<0.01	<0.01	DIN EN ISO 62
Mechanical properties	Tensile stress at yield	N/mm ²	20	20	20	ISO 527-1
	Elongation at yield stress	%	13	15	12	ISO 527-1
	Elongation at break	%	>50	>50	>50	ISO 527-1
	Hardness	Shore D	63	60	65	ISO 868
	Coefficient of sliding friction	ml/mm ²	0.08	0.1	0.15	ISO 179
Thermal properties	Thermal conductivity	W/mK	0.41	0.40	0.40	DIN 52612
	Coefficient of linear expansion between 20°C and 100°C	1/K	2x10 ⁻⁴	2x10 ⁻⁴	2x10 ⁻⁴	DIN 53752
	Vicat-softening temp. -VST/B50	°C	79	80	-	ISO 306
	Temperature range	°C	-50/+110	-50/+70	-50/+70	-
Electrical properties	Insulation resistivity	Ohm x cm	>10 ¹⁵	>10 ¹²	>10 ¹²	IEC 60093
	Surface resistivity	Ohm	>10 ¹⁴	>10 ¹²	>10 ¹²	IEC 60093

The data mentioned in table are average values ascertained by current statistical returns and tests.
The data above are provided purely for information and shall not be regarded as binding.
Other qualities and dimensions on request.

Trellex LF fixing methods

Standard attachment system for Trellex LF thickness 6 mm

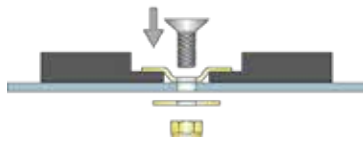

Throughbolt system

Standard attachment system for Trellex LF thickness 10-25 mm

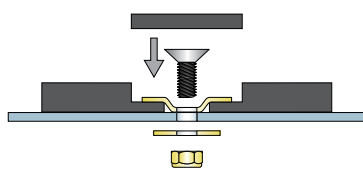

Throughbolt system

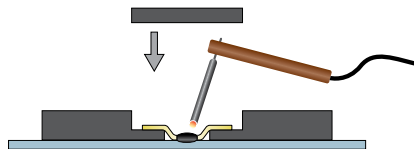

Weld washer system >10 mm

Other fastening method upon request

Trellex LF fixing parts

Part no.	Description	Weight (kg/ea)
ZX11214866	Fixing/welding washer dia 35	0.013
2971560	Bolt MF6S 8x40	0.015
819623	Washer BRB 10,5/22x2	0.0046
660795	Nut nyloc M8	0.0056
ZX11214867	Plug Ø 38x4 for Trellex LF plate 10 mm	0.005
ZX11263541	Plug Ø 38x9 for Trellex LF plate 15 mm	0.0135
ZX11263542	Plug Ø 38x13 for Trellex LF plate 20 mm	0.0195
ZX11265097	LF drill	1.85
ZX11300365	Plug Ø 38x13 for Trellex LF plate 25 mm	0.0210

Fixing of LF plates thicker than 25 mm, please contact your local Metso Outotec support.

Tolerances LF plates:

	6 mm sheets	>10 mm sheets
Width	-0.0/+10	+30
Length	-0.0/+30	+60

Trellex LF - installation

Recommended fixing pattern

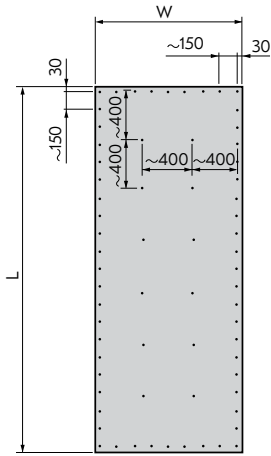

Calculate with 20 fixings/m².

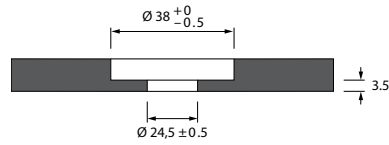

Dimensions for drilling of LF fixing

Overlap/joint methods/solutions.
Made by cutting or milling. ➔ Material flow

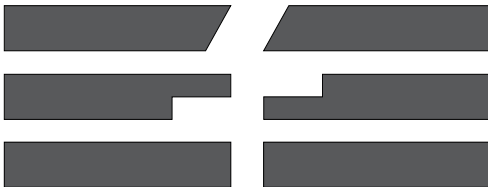

For cutting joint/s as shown we recommend using the same tooling intended for wood.

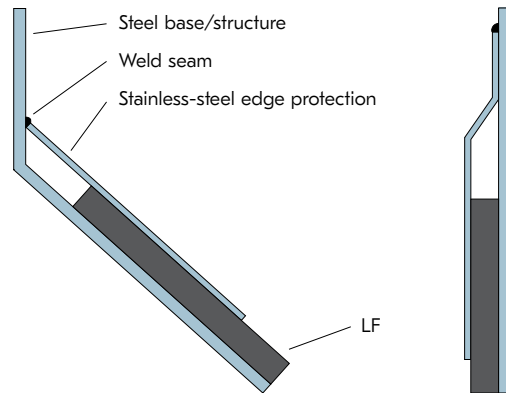

Flexback PU

Resists pH values between 4-11, but is not designed for underwater applications. Resists attack from most oils and chemicals and in environments exposed to ozone. Supplied with a standard hardness of 80 sH(A) (yellow). Also available as alternatives in hardnesses of 70 sH(A) (blue) and 90 sH(A) (green).



Trellex Flexback PU standard range			
Part no.	Description	Width x Length (mm)	Weight (kg/ea)
690310-80	FBU 10	1,270 x 3,000	60
690315-80	FBU 15	1,270 x 3,000	84
690320-80	FBU 20	1,270 x 3,000	106

Trellex Flexback fixing methods

Standard attachment system

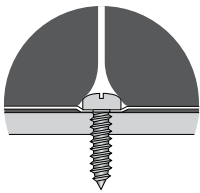

Self-tapping screw

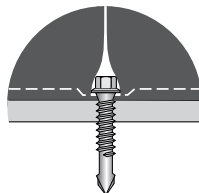

Drill & self-tapping screw

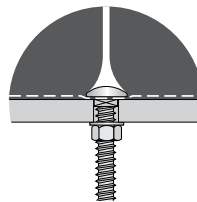

Carriage bolt

Customized fastening pattern limits		
Measurements	Min (mm)	Max (mm)
A	20	50
B	50	200*
C	50	600

Standard fastening pattern Flexback PU

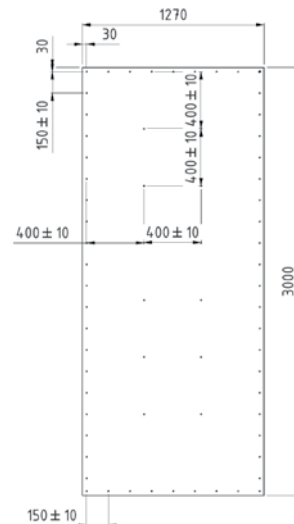
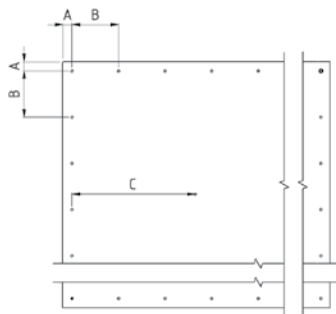

Ceramic wear lining

Ceramic wear lining

Metso Outotec ceramic wear lining provides excellent wear resistance in applications with sliding wear and high material speeds, particularly where the material has only a slight impact angle. The unique design of ceramic inserts improves wear life and impact resistance. The ceramic wear lining also reduces noise and vibration in the application.

Wear-life improvement

Improve the wear life of the original equipment by protecting it with ceramic wear plates – for wet or dry applications, small to medium heavy materials and low impact angles. All for reaching the maximal lifetime and production capacity.

Flow improvement

Improve poor material flow caused by narrow sectors in the process. Such spots can be real bottlenecks and create a lot of additional work and unplanned downtime.

Noise reduction

Excessive noise is a problem in mining and aggregate operations. Managing noise pollution is more important than ever. All ceramic wear products reduce noise and thereby contribute to a better work environment.



Trellex SQ300 Ceramic

A modern wear protection system that reduces impacts and improves health and safety without increasing costs or sacrificing operational efficiency. The modular system can handle particle sizes up to 200 mm (8") and resists pH values 4-9 and all water types, and most oils and chemicals in moderate/ small concentrations (see separate SQ 300 section).

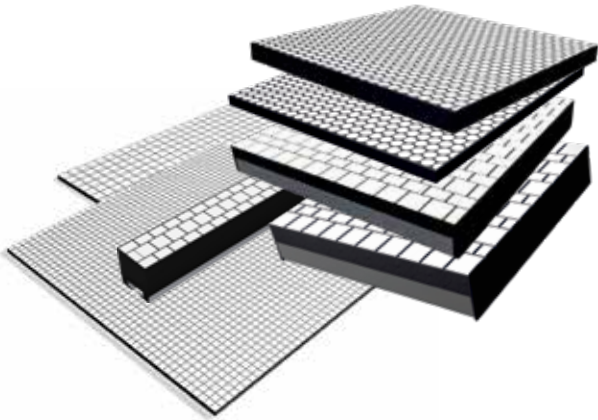

Trellex Poly-Cer

Hard ceramic surfaces provide unsurpassable wear resistance while the elasticity of the rubber absorbs the impact of blows. Excellent wear resistance in applications with sliding wear and high material speeds.

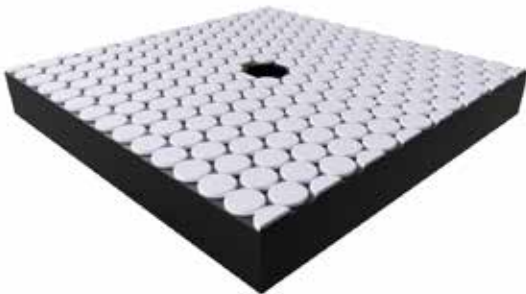

Xlok Ceramic

A tough modular liner system and the ultimate choice for situations where equipment can only be accessed from the inside. Available in a range of material options to suit the application, including cast metallic options, rubber and ceramic products (see separate Xlok section under attachment systems).

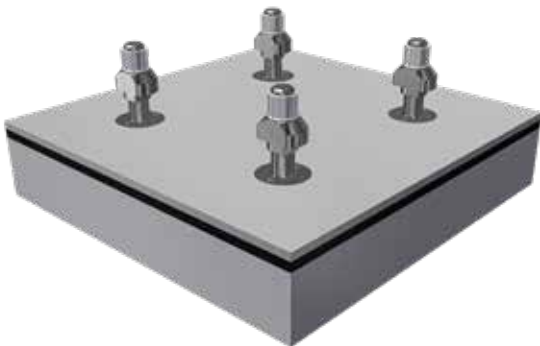

Ceramic TT

A tough modular liner system and the ultimate choice for situations where equipment can only be accessed from the inside. Available in a range of material options to suit the application, including cast metallic options, rubber and ceramic products (see separate Ceramic TT section under attachment systems).

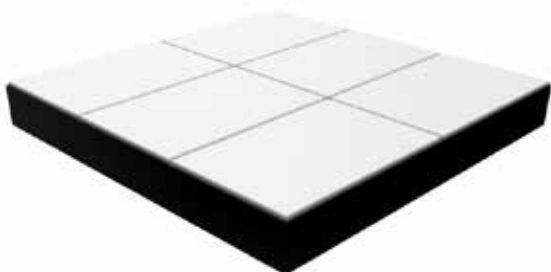

X92 and ZTA

Ceramic element in modular dimension with high wear-resistant alumina or zirconia toughened alumina vulcanized with wear-resistant rubber. A hot-vulcanized steel backing plate for secured fastening with welded studs. Ideal for applications where impact is low to moderate and severe abrasion resistance is required.

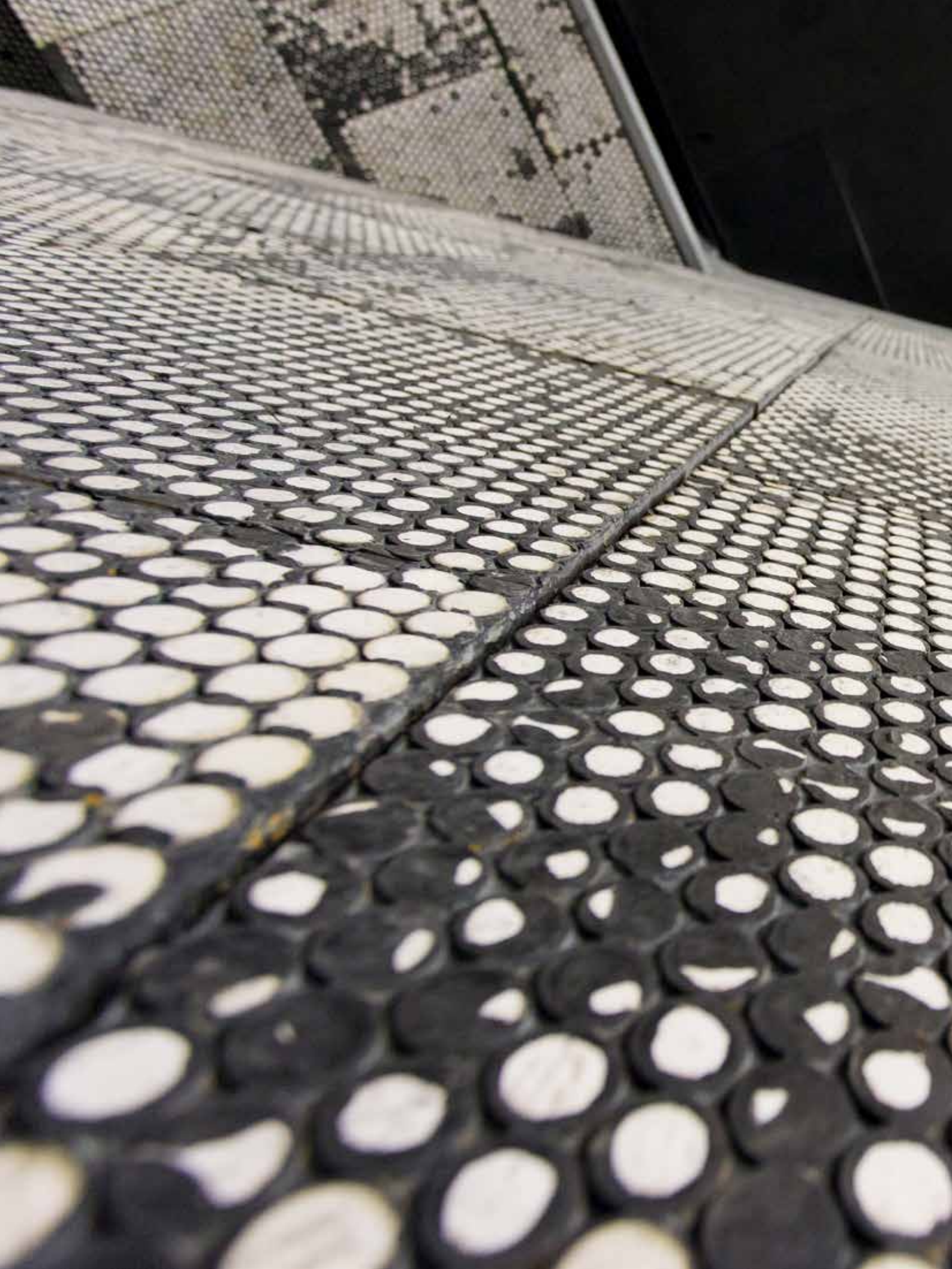

Trellex Poly-Cer™

Wear elements made of rubber and ceramic

- Unique design
- Excellent wear resistance
- Impact absorption

Excellent wear resistance in applications with sliding wear and high material speeds, particularly where the material has only a slight impact angle. The unique design of ceramic inserts improves wear life and impact resistance. Trellex Poly-Cer also reduces noise and vibration in the application.

Choice of materials

Trellex Poly-Cer 10S, 20S, 38S and 70S are engineered using T60 wear rubber with built-in ceramics and enhanced with fixed, hot-vulcanized steel reinforcement. The steel backing prevents small particles from getting under the lining and guarantees secure fixing.

Trellex Poly-Cer 4S is engineered using wear rubber with built-in ceramics hot-vulcanized together and combined with a contact layer.

Trellex Poly-Cer wear elements are available in thicknesses of 8 mm (4S), 20 mm (10S), 35 mm (20S), 64 mm (38S) and 95 mm (70S). Trellex Poly-Cer WB 100/38S is designed with built-in ceramics in the wear rubber at the top of the bar and a hot-vulcanized aluminum track at the bottom part.

The elements are manufactured in modular dimensions and can be offered in custom shapes.

Technical description

Trellex Poly-Cer resists pH values 4-9 and all water types, and most oils and chemicals in moderate/small concentrations.

Other information

Trellex Poly-Cer is most effective in the -30° - 70°C temperature range.

Installation

Poly-Cer provides excellent wear protection in demanding applications like feeders, bins, transfer chutes, silos, transfer points and any other applications that are subject to heavy wear and noise. Poly-Cer is ideal for medium-heavy applications in the rock and gravel industry, or for secondary and lighter applications. Poly-Cer 4S is optimized for medium to light mining, rock and gravel industries with lighter applications.

Trellex Poly-Cer can be installed with a stud-welded bolt system. Poly-Cer 4S can be installed according to the sheeting range, and Poly-Cer WB can be installed according T-bolt system.

Trellex Poly-Cer product range

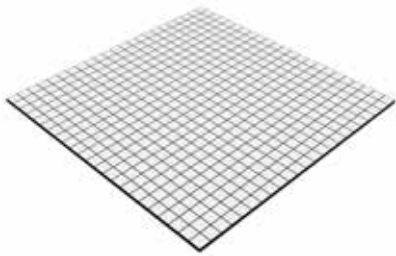

Trellex Poly-Cer 4S 8/0

Poly-Cer 4S is engineered using wear rubber with built-in ceramics hot-vulcanized together and combined with a contact layer. Excellent wear resistance in applications with sliding wear and high material speeds, particularly where the material has only a slight impact angle. Poly-Cer 4S is optimized for medium to light applications in the mining and aggregate industries.

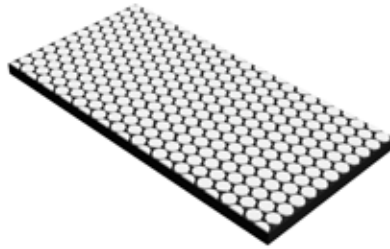

Trellex Poly-Cer 10S 20/5

Excellent wear protection for tough conditions with low impact angles and high material flows. Trellex Poly-Cer 10S is the thin alternative for applications with limited lining thickness and weights. Typical applications are feeders, chutes, and transfer points in conveyor systems.

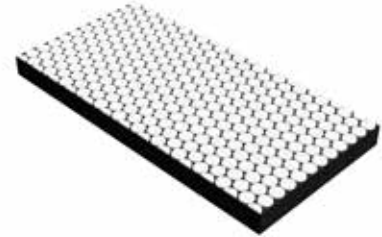

Trellex Poly-Cer 20S 35/5

The Nestor in the Poly-Cer family, with more than 25 years behind it, Trellex Poly-Cer 20S is a wear plate for a wide range of applications. Excellent performance with large volumes and high material velocities. Typical applications are chutes and transfer points in conveyor systems, as well as material deflectors and screening chutes.



Trellex Poly-Cer 38S 64/5

The unique design of the ceramic elements and its zig-zag pattern provides excellent wear protection for tougher applications with large material, high volume flows and angled impact. Patent pending.



Trellex Poly-Cer 70S 95/5

An even more heavy-duty version Trellex Poly-Cer, with the same unique design of the ceramic elements in a zig-zag pattern. Trellex Poly-Cer 70S handles extreme material, volumes, high volumes and tough impact angles. The solution to the toughest and hardest wear problems. Patent pending.



Trellex Poly-Cer WB

A wear bar with a hot-vulcanized track in bottom for secured T-bolt fastening, 100 mm wide and 100 mm high. A top surface with the unique design of the ceramic elements in a zig-zag pattern.

Trellex Poly-Cer standard product range

Part no.	Description	Thickness x Width x Length (mm)	Weight (kg)
1017803	Trellex Poly-Cer 4S 8/0	8 x 500 x 500 (tiles 10 x 10 x 4)	4.7
1017804	Trellex Poly-Cer 4S 8/0	8 x 500 x 500 (tiles 20 x 20 x 4)	4.7
6650517	Trellex Poly-Cer 10S 20/5	20 x 200 x 400	5.8
6650518	Trellex Poly-Cer 10S 20/5	20 x 400 x 400	11.6
6660301	Trellex Poly-Cer 10S 20/5	20 x 500 x 250	8.6
6660300	Trellex Poly-Cer 10S 20/5	20 x 500 x 500	17.3
6650519	Trellex Poly-Cer 20S 35/5	35 x 200 x 400	8.3
MM0407488	Trellex Poly-Cer 20S 35/5	35 x 229 x 457 (9" x 18")	11.0
ZX11333210	Trellex Poly-Cer 20S 35/5	35 x 300 x 300	9.6
442502.3	Trellex Poly-Cer 20S 35/5	35 x 305 x 305	10.0
MM0407486	Trellex Poly-Cer 20S 35/5	35 x 305 x 610	19.9
6650520	Trellex Poly-Cer 20S 35/5	35 x 400 x 400	16.6
6660247	Trellex Poly-Cer 20S 35/5	35 x 500 x 200	10.7
2939790	Trellex Poly-Cer 20S 35/5	35 x 500 x 250	13.0
6610096	Trellex Poly-Cer 20S 35/5	35 x 500 x 300	16.0
2939780	Trellex Poly-Cer 20S 35/5	35 x 500 x 500	26.7
6650522	Trellex Poly-Cer 38S 64/5	64 x 200 x 400	14.0
MM0407628	Trellex Poly-Cer 38S 64/5	64 x 229 x 457 (9" x 18")	23.0
6610558	Trellex Poly-Cer 38S 64/5	64 x 244 x 502	22.0
6610557	Trellex Poly-Cer 38S 64/5	64 x 262 x 502	24.0
6620390	Trellex Poly-Cer 38S 64/5	64 x 302 x 304	16.5
MM0407626	Trellex Poly-Cer 38S 64/5	64 x 305 x 305	20.5
MM0407627	Trellex Poly-Cer 38S 64/5	64 x 305 x 610	40.9
6650521	Trellex Poly-Cer 38S 64/5	64 x 400 x 400	29.0
6620273	Trellex Poly-Cer 38S 64/5	64 x 500 x 502	55.0
6650524	Trellex Poly-Cer 70S 95/5	95 x 200 x 400	22.1
6620347	Trellex Poly-Cer 70S 95/5	95 x 250 x 500	35.5
6650523	Trellex Poly-Cer 70S 95/5	95 x 400 x 400	44.6
6620346	Trellex Poly-Cer 70S 95/5	95 x 500 x 500	71.0
MM0372088	Trellex Poly-Cer WB 100/38S	100 x 100 x 1500	27.0

Custom-made dimensions upon request.

Trellex Poly-Cer bending radius

Trellex Poly-Cer 4S

Concave bending

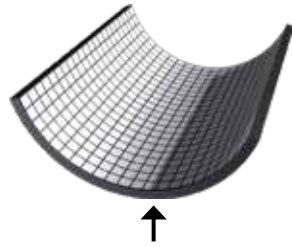

Convex bending

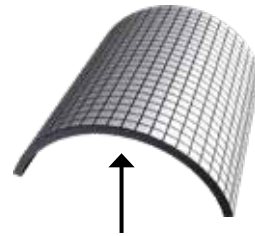

Type of Poly-Cer	Minimum radius (installation surface)	Minimum radius (installation surface)
4S tile 10x10	50 mm	50 mm*
4S tile 20x20	100 mm	100 mm*

*Not standard design, contact product specialist.

Trellex Poly-Cer 10S, 20S, 38S and 70S

Concave bending

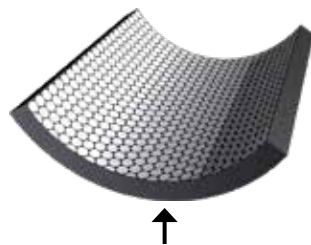

Convex bending

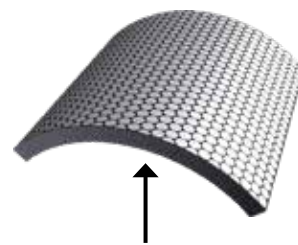

Type of Poly-Cer	Minimum radius (installation surface)	Minimum radius (installation surface)
10S (Slim)	250 mm	280 mm*
20S (Classic)	285 mm	315 mm*
38S (HD64)	Non standard**	Not applicable
70S (HD95)	Non standard**	Not applicable

*Not standard design, contact product specialist.

**Available for limited radius, contact product specialist.

Fixing methods Trellex Poly-Cer 10S, 20S, 38S and 70S



Stud-welded bolt



Self-tapping screw



Plug welding

Stud-welding standard fixing kits

Trellex stud-welding kit M12 wet application	
Part no.	Description
MM0371834	Trellex stud-welding kit M12 wet
Items included in kit	
Part no.	Description
2878030	Trellex stud bolt M12x50 RD incl. ferrule
ML-248000	ML-sealer 40/12-12
ML-217320	ML-cupwasher 54/40/15-14@
294215	SM-acc nut nyloc M12

Trellex stud-welding kit M12 dry application	
Part no.	Description
MM0371833	Trellex stud-welding kit M12 dry
Items included in kit	
Part no.	Description
6640541	Trellex stud bolt M12x40 RD incl. ferrule
00921305012S	Washer, plain ISO7089-12-200hv-a3a@
294215	SM-acc nut nyloc M12

Trellex stud-welding kit M16 wet application	
Part no.	Description
MM0371837	Trellex stud-welding kit M16 wet
Items included in kit	
Part no.	Description
2878010	Trellex stud bolt M16x50 RD incl. ferrule
ML-248001	ML-sealer 40/16-12
ML-217321	ML-cupwasher 54/40/18-14@
315150	SMS-L acc nut M16 nyloc

Trellex stud-welding kit M16 dry application	
Part no.	Description
MM0371836	Trellex stud-welding kit M16 dry
Items included in kit	
Part no.	Description
MM0378227	Trellex stud bolt M16x40 RD incl. ferrule
212803	SMS-L acc washer brb 3x17/30
315150	SMS-L acc nut M16 nyloc

Trellex stud-welding kit M20 wet application	
Part no.	Description
MM0371839	Trellex stud-welding kit M20 wet
Items included in kit	
Part no.	Description
596726	Trellex stud bolt M20x50 RD incl. ferrule
ML-248004	ML-sealer 60/20-12@
ML-217324	ML-cupwasher 80/60/22-17@
213587	SMS-L acc nut M20 nyloc

Trellex stud-welding kit M20 dry application	
Part no.	Description
MM0371838	Trellex stud-welding kit M20 dry
Items included in kit	
Part no.	Description
596726	Trellex stud bolt M20x50 RD incl. ferrule
352393	SMS-L acc washer brb 3x21/36
213587	SMS-L acc nut M20 nyloc

Standard fixing sets for Poly-Cer WB 100/38S

Wet application		
Part. no	Description	Weight (kg/ea)
2934210	Trellex T-bolt 35/55 M16 x 70/55	0.22
ML-248001	Rubber sealing 40/16-12	0.02
ML-200014	Cupwasher 40/18-11	0.1
315150	Nut M16 nyloc	0.035



Trellex Poly-Cer installation guideline

Direction of flow

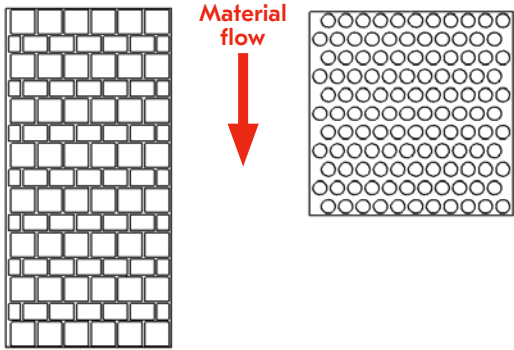

Ceramic inserts should be placed in a zig-zag pattern against the material flow, as shown above.

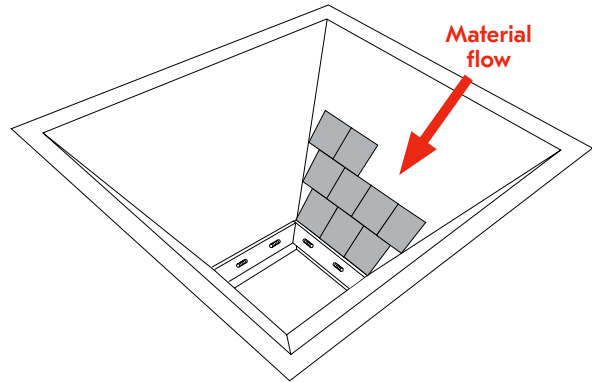

Poly-Cer plates should be placed in a zig-zag pattern against the material flow, as shown above.

Stud-welds

1. Knock a center punch in the center of the markings.
Degrease the metal surface with a solvent.
2. Grind/clean around the markings, remove all rust etc.
Do not grind away the punch markings.
3. Permanently weld the studs using stud-welding equipment.

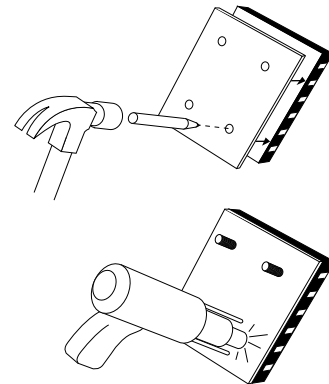

Customized fastening pattern limits		
Measurement	Min (mm)	Max (mm)
A	50	150
B	50	300

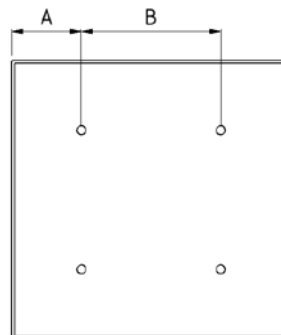

Trellex Poly-Cer fixing methods

Trellex Poly-Cer 4S

Preparation of the metal surface

1. The metal surface must be free of rust, dirt and other deposits.
The best way is to sandblast the area. It is also possible to use a grinder.
2. Degrease the metal surface with a solvent.
3. Brush on a thin layer of Trellex Steel Primer P5.
The normal drying time for a P5 layer is at least 30 min.

Glueing steps

1. Brush the first layer of glue onto the steel-primed metal surface and let it dry for at least 30 minutes.
2. Clean up the contact layer with a solvent. Let it dry.
3. Brush the first layer of glue onto the contact layer surface and let it dry for at least 30 minutes.
4. Brush the second layer of glue onto the metal surface.
5. Brush the second layer of glue onto the contact layer surface.
6. When both surfaces are sticky, put them together;
the glue layers must be sticky and not leave any black traces. Back of the hand test.
NOTE! Do not put the material together too soon, as there is a risk that the layers will not achieve full contact strength.
7. Ensure that any air bubbles and creases are eliminated. Use a roller and a recoil-free hammer. Start in the middle and work outward to the edges.
NOTE! The maximum glue strength is achieved after 24 hours.

Additional info

Trellex Adhesives Steel Primer P5 part no. 2322060,
consumption guideline 0.2 l/m²/layer

Trellex Adhesives Greenbond incl hardener, part no. 2322040,
consumption guideline 0.4 l/m²/layer

Trellex Poly-Cer standard fastening patterns

Standard fastening pattern with stud-welded bolt

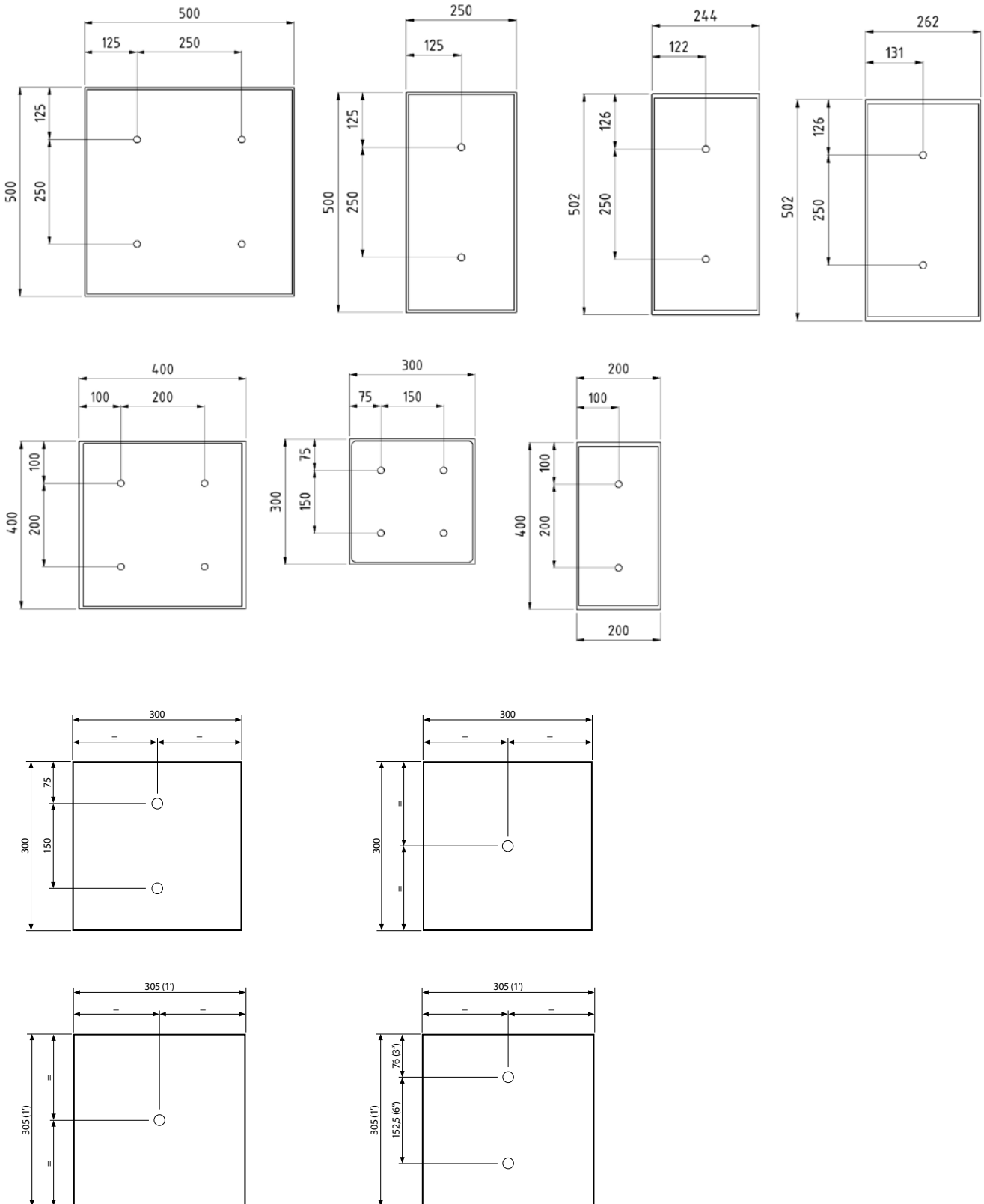

Trellex Poly-Cer general selection guide

Poly-Cer 4S	
Max drop height	1 m
Wear angle	0°-20°
Material size	max 25 mm, F75 - 10 mm

Poly-Cer 10S and 20S

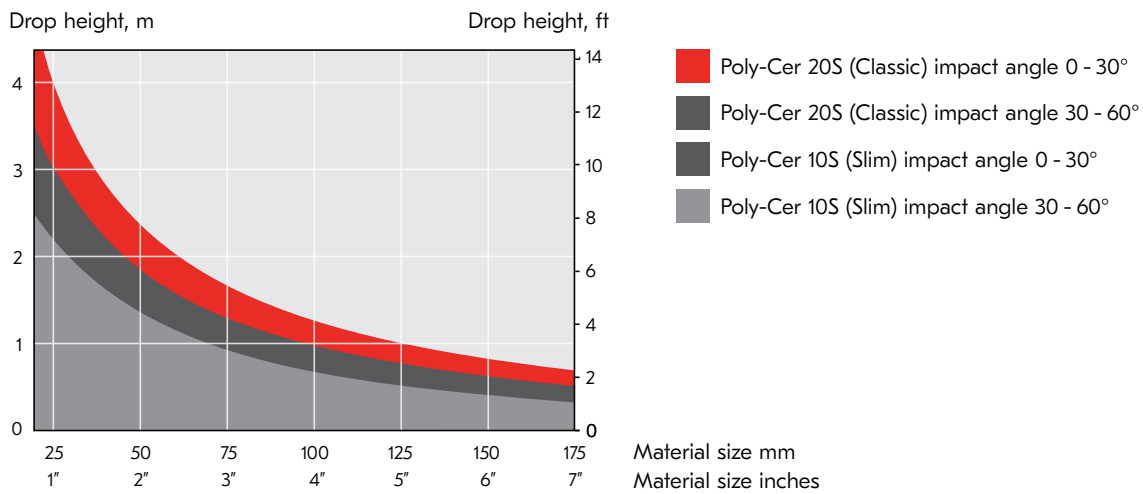

Poly-Cer 38S and 70S

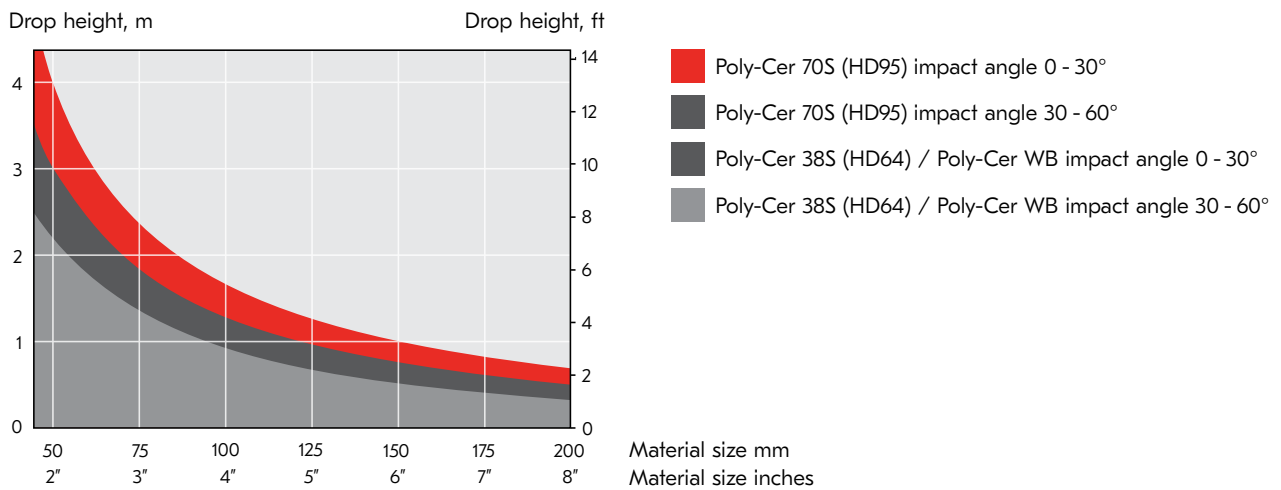

Trellex Poly-Cer X92 and ZTA

Steel-backed wear elements made of rubber and ceramic

- Wear resistance
- Impact absorption
- Hot-vulcanized
- Modular dimension

Excellent wear resistance in applications with sliding wear and high material speeds, particularly where the material has a low to moderate impact angle. The high-quality ceramic inserts, in combination with wear- and impact-resistant rubber, improve wear life and increase efficiency. A hot-vulcanized wear element, bonding steel plate with wear-resistant rubber and high-quality ceramic insert, provides a wear-resistant element for mining and aggregate applications.

Choice of materials

Trellex Poly-Cer X92 and ZTA are engineered using T60 wear rubber with built-in ceramics and enhanced with fixed, hot-vulcanized steel reinforcement. The steel backing prevents small particles from getting under the lining and guarantees secure fixing.

Trellex Poly-Cer X92 and ZTA wear elements are available in thicknesses of 37 mm and 63 mm. The high-quality ceramic inserts are available in two versions:

- **X92** - containing a 92% aluminum oxide grade for use in applications with low to moderate impact and where severe abrasion resistance is required
- **ZTA** - Zirconia toughened alumina tiles that give the elements increased resistance to cracking compared to standard alumina based elements. Ideal for use in applications with moderate to high impact and where extreme abrasion resistance is required. The element combines abrasion and impact resistance for applications in harsh environments

The elements are manufactured in modular dimensions and can be offered in custom shapes.

Technical description

Resists pH values 4-9 and all water types, and most oils and chemicals in moderate/small concentrations.

Other information

Trellex Poly-Cer X92 and ZTA are most effective in the -30° to +70°C temperature range.

Installation

Trellex Poly-Cer X92 and ZTA provide excellent wear protection in feeders, bins, silos, transfer chutes, transfer points and any other mining and aggregate applications that are subject to heavy wear and noise pollution. The elements are easily installed by using a stud-welded bolt system for quick and safe attachment. Poly-Cer X92 and ZTA can be supplied utilizing Metso Outotec's CTT system for wear side only installation. Please see the Attachments section for further information.

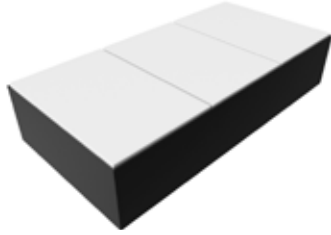

Trellex Poly-Cer 150 x 300 mm

Version	X92		ZTA	
Element thickness (mm)	37	63	37	63
Ceramic thickness (mm)	25	50	25	50

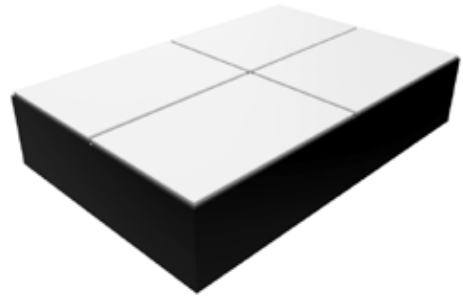

Trellex Poly-Cer 200 x 300 mm

Version	X92		ZTA	
Element thickness (mm)	37	63	37	63
Ceramic thickness (mm)	25	50	25	50

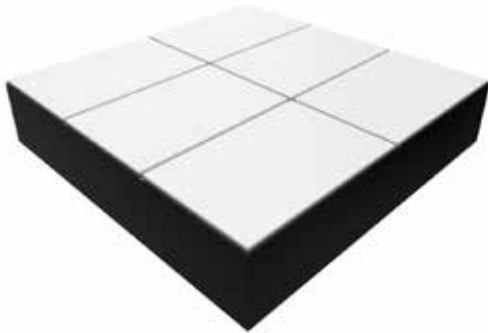

Trellex Poly-Cer 300 x 300 mm

Version	X92		ZTA	
Element thickness (mm)	37	63	37	63
Ceramic thickness (mm)	25	50	25	50



Trellex Poly-Cer 400 x 300 mm

Version	X92		ZTA	
Element thickness (mm)	37	63	37	63
Ceramic thickness (mm)	25	50	25	50

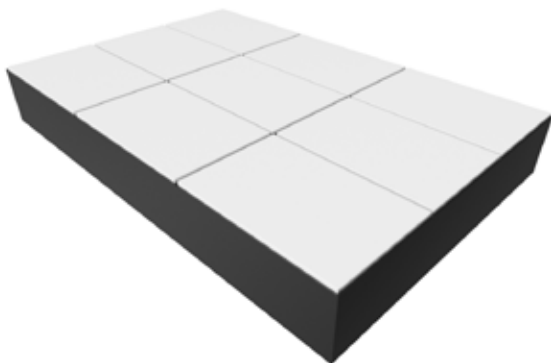

Trellex Poly-Cer 450 x 300 mm

Version	X92		ZTA	
Element thickness (mm)	37	63	37	63
Ceramic thickness (mm)	25	50	25	50

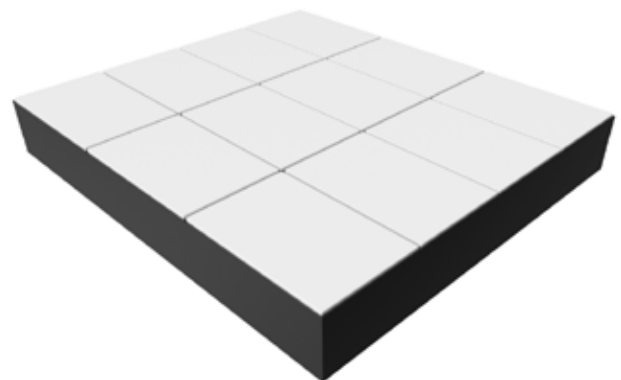

Trellex Poly-Cer 450 x 400 mm

Version	X92		ZTA	
Element thickness (mm)	37	63	37	63
Ceramic thickness (mm)	25	50	25	50

Trellex Poly-Cer X92 and ZTA

Poly-Cer X92 and ZTA can be customized to provide unique shapes for optimized wear solutions. Metso Outotec offers and develops full liner packages to support customer needs and has the capability to chamfer and cut liners to create custom non-standard shapes and solutions, allow for non-standard bolting pattern, create liners with Xalloy AR edge protection, etc.

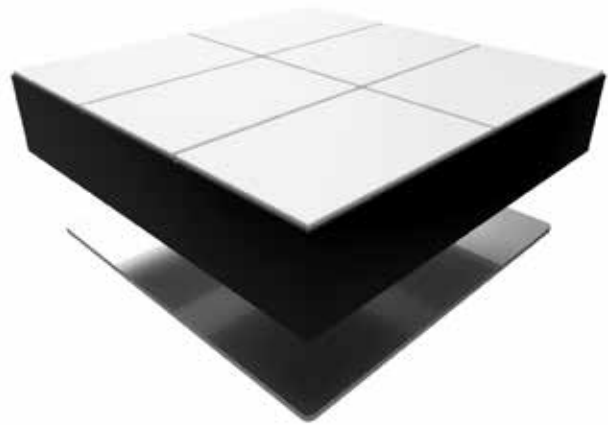

Trellex Poly-Cer X92 standard range				
Part no.	Description	Thickness (mm)	Width x Length (mm)	Weight (kg/ea)
MM1520464	Trellex PC X92 25L-T147x97-37/5-150-300	37	150 x 300	5.7
MM1563289	Trellex PC X92 25L-T147x97-37/5-200-300	37	200 x 300	7.7
MM1520447	Trellex PC X92 25L-T147x97-37/5-300-300	37	300 x 300	11.6
MM1563306	Trellex PC X92 25L-T147x97-37/5-300-400	37	400 x 300	15.5
MM1563313	Trellex PC X92 25L-T147x97-37/5-300-450	37	450 x 300	17.5
MM1563318	Trellex PC X92 25L-T147x97-37/5-400-450	37	450 x 400	23.4
MM1520489	Trellex PC X92 50L-T147x97-63/5-150-300	63	150 x 300	9.6
MM1520511	Trellex PC X92 50L-T147x97-63/5-200-300	63	200 x 300	13.2
MM1520379	Trellex PC X92 50L-T147x97-63/5-300-300	63	300 x 300	19.5
MM1520517	Trellex PC X92 50L-T147x97-63/5-300-400	63	400 x 300	26,0
MM1520526	Trellex PC X92 50L-T147x97-63/5-300-450	63	450 x 300	32.9
MM1520523	Trellex PC X92 50L-T147x97-63/5-400-450	63	450 x 400	39.1

Standard range elements are manufactured without studs. Elements including studs are available on request. Custom shapes made on request.

Trellex Poly-Cer ZTA standard range				
Part no.	Description	Thickness (mm)	Width x Length (mm)	Weight (kg/ea)
MM1564784	Trellex PC ZTA 25Z-T147x97-37/5-150-300	37	150 x 300	5.7
MM1568886	Trellex PC ZTA 25Z-T147x97-37/5-200-300	37	200 x 300	7.7
MM1568905	Trellex PC ZTA 25Z-T147x97-37/5-300-300	37	300 x 300	11.6
MM1568937	Trellex PC ZTA 25Z-T147x97-37/5-300-400	37	400 x 300	15.5
MM1568950	Trellex PC ZTA 25Z-T147x97-37/5-300-450	37	450 x 300	17.5
MM1568954	Trellex PC ZTA 25Z-T147x97-37/5-400-450	37	450 x 400	23.4
MM1569015	Trellex PC ZTA 50Z-T147x97-63/5-150-300	63	150 x 300	9.6
MM1569021	Trellex PC ZTA 50Z-T147x97-63/5-200-300	63	200 x 300	13.2
MM1569027	Trellex PC ZTA 50Z-T147x97-63/5-300-300	63	300 x 300	19.5
MM1569036	Trellex PC ZTA 50Z-T147x97-63/5-300-400	63	400 x 300	26,0
MM1569042	Trellex PC ZTA 50Z-T147x97-63/5-300-450	63	450 x 300	32.9
MM1569059	Trellex PC ZTA 50Z-T147x97-63/5-400-450	63	450 x 400	39.1

Standard range elements are manufactured without studs. Elements including studs are available on request. Custom shapes made on request.



Properties

Trellex Poly-Cer X92	
Properties	Value
Rubber hardness	60 Shore A
Ceramic hardness	≥ 82 HRA
Element thickness	37 mm & 63 mm
Ceramic tile thickness	25 mm & 50 mm
Ceramic density	≥ 3.60 g/cm ³
Ceramic bending strength	≥ 220 Mpa
Chemical composition - Al ₂ O ₃	≥ 92 wt%

Trellex Poly-Cer ZTA	
Properties	Value
Rubber hardness	60 Shore A
Ceramic hardness	≥ 90 HRA
Element thickness	37 mm & 63 mm
Ceramic tile thickness	25 mm & 50 mm
Ceramic density	≥ 4.15 g/cm ³
Ceramic bending strength	≥ 400 Mpa
Chemical composition - Al ₂ O ₃	≥ 75wt%
Chemical composition - ZrO ₂	≥ 21wt%

Trellex Poly-Cer X92 and ZTA

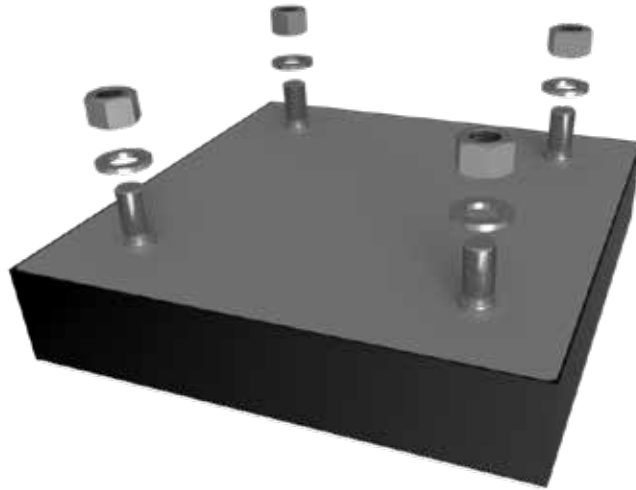

Trellex Poly-Cer X92 and Trellex Poly-Cer ZTA fixing methods					
Recommended stud bolts	Trellex Poly-Cer X92		Trellex Poly-Cer ZTA		Recommended torque (Nm)
	37 mm	63 mm	37 mm	63 mm	
M16 (5/8")	Standard		Standard		110
M20 (3/4")		Standard		Standard	220

Stud-welding standard fixing sets

Trellex stud-welding kit M16 Wet application	
Part no.	Description
MM0371837	Trellex stud-welding kit M16 Wet
Items included in kit	
Part no.	Description
2878010	Trellex stud bolt M16x50 RD incl. ferrule
ML-248001	ML-sealer 40/16-12
ML-217321	ML-cupwasher 54/40/18-14@
315150	SMS-L acc nut M16 nyloc

Trellex stud-welding kit M16 Dry application	
Part no.	Description
MM0371836	Trellex stud-welding kit M16 Dry
Items included in kit	
Part no.	Description
MM0378227	Trellex stud bolt M16x40 RD incl. ferrule
212803	SMS-L acc washer brb 3x17/30
315150	SMS-L acc nut M16 nyloc

Trellex stud-welding kit M20 Wet application	
Part no.	Description
MM0371839	Trellex stud-welding kit M20 Wet
Items included in kit	
Part no.	Description
596726	Trellex stud bolt M20x50 RD incl. ferrule
ML-248004	ML-sealer 60/20-12@
ML-217324	ML-cupwasher 80/60/22-17@
213587	SMS-L acc nut M20 nyloc

Trellex stud-welding kit M20 Dry application	
Part no.	Description
MM0371838	Trellex stud-welding kit M20 Dry
Items included in kit	
Part no.	Description
596726	Trellex stud bolt M20x50 RD incl. ferrule
352393	SMS-L acc washer brb 3x21/36
213587	SMS-L acc nut M20 nyloc

Trellex Poly-Cer X92 and ZTA

Standard fastening pattern with stud-welded bolt

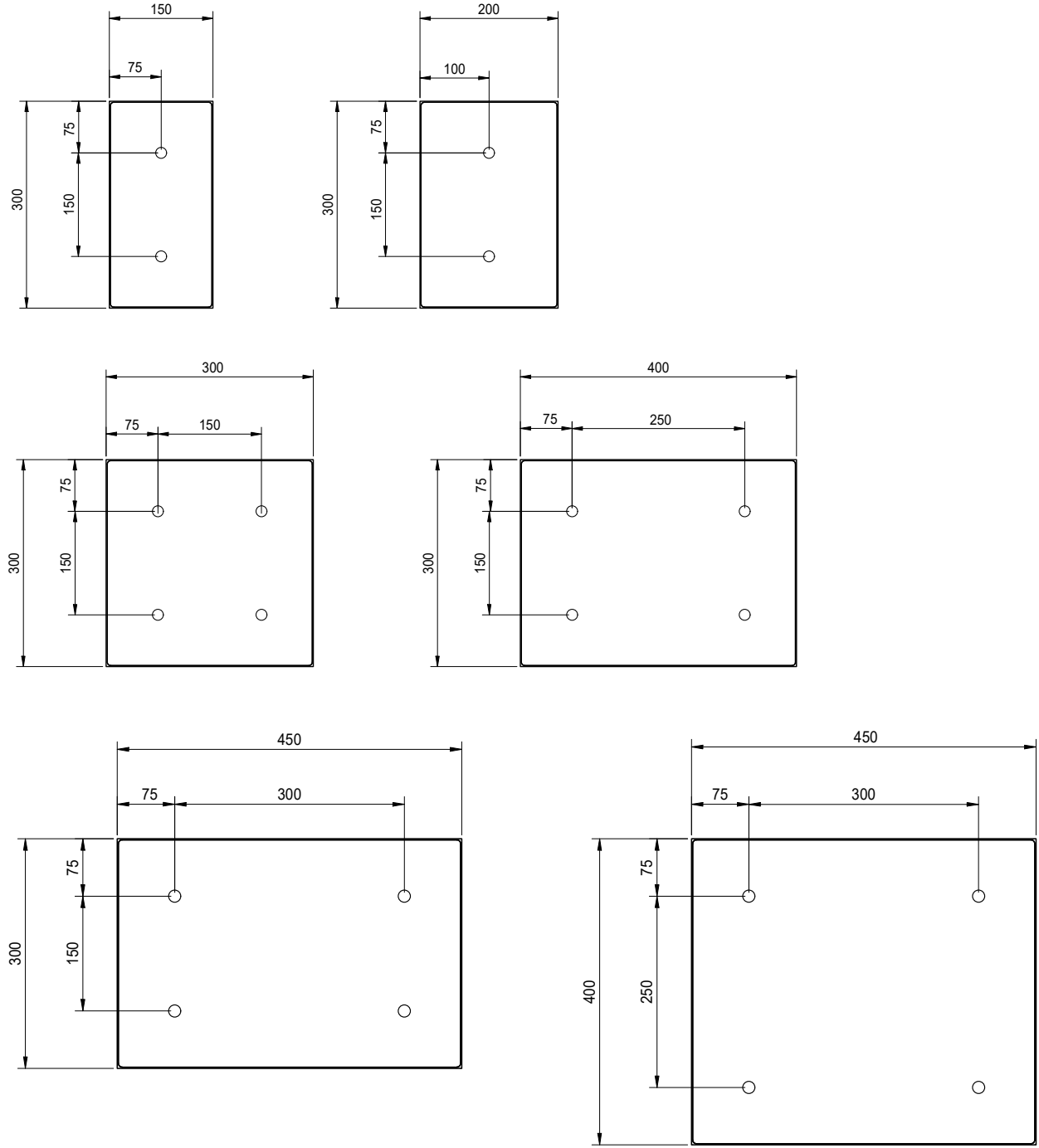

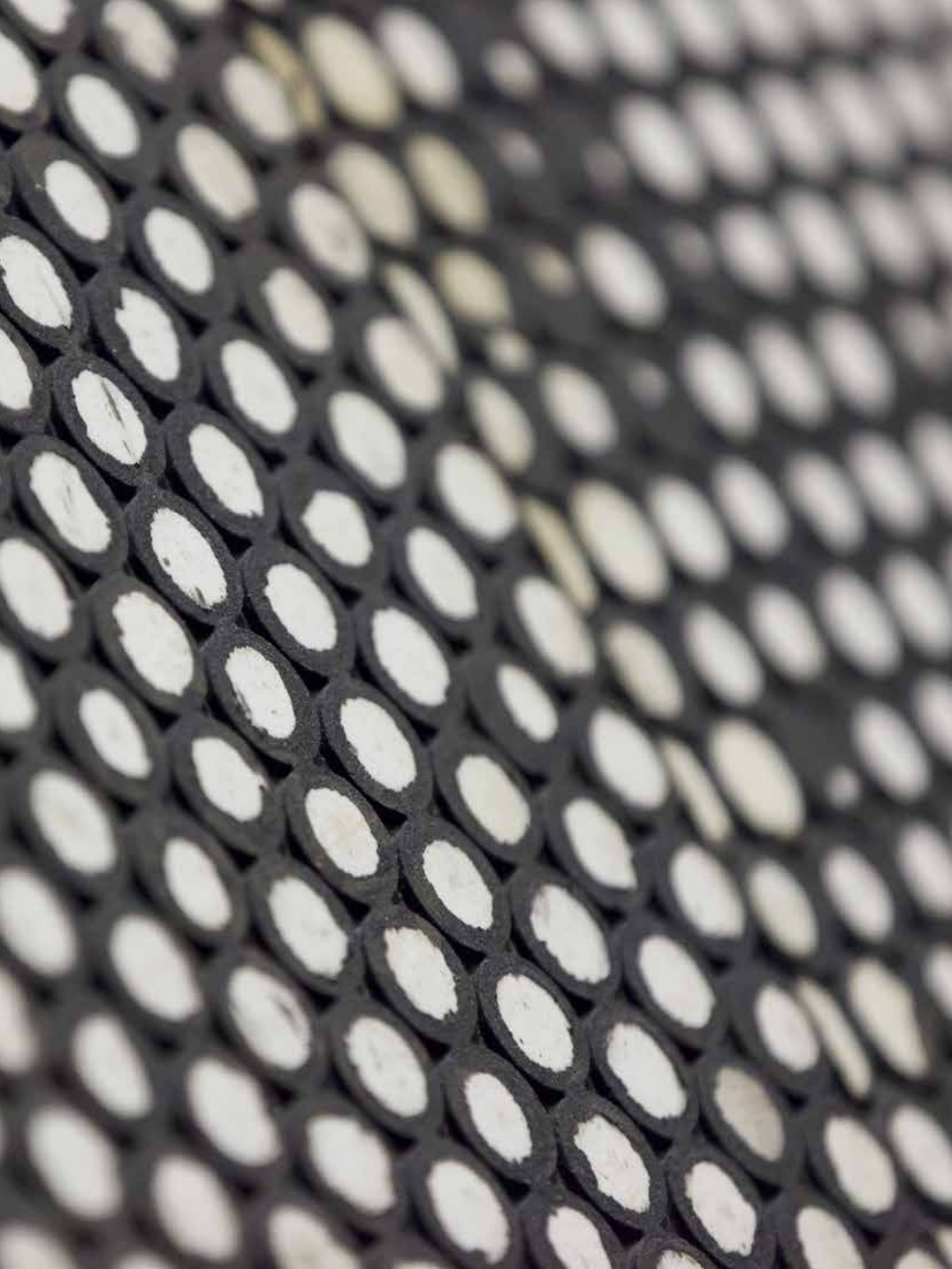

Sheetings & Coatings

Trellex wear-resistant sheeting

By choosing Trellex wear-resistant sheeting from Metso Outotec you are choosing first-class wear protection. Our rubber compounds, especially T60 and T40, have been the most premium within the industry since the 1960s.

Soft or hard, wet or dry, our range of rubber sheeting can tackle all applications and has proved to bring long wear life and improve the working environment. Rubber sheeting is often seen as a light-duty wear protection; but when it comes to things like reducing noise and weight, the performance and the flexibility of rubber is anything but light.

When choosing a rubber sheeting product, a well-functioning attachment system is a must; our rubber sheeting range offers a wide selection of attachment options. In addition to our sheeting range, our Xresist epoxy system supports safe and quick repairs as well as other, more permanent applications.



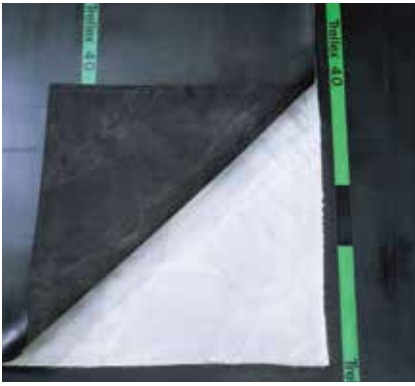

Trellex T40

Sheeting intended mainly for sliding and blasting abrasion and for small particle sizes. Extremely high wear resistance against fine-grained, slurried materials. Tolerates operating temperatures of 60-70°C. Available in 3 options: smooth, contact layer and tear off.



Trellex T60

A rubber grade satisfying extremely high requirements of wear and tear and impact. Outstanding for abrasive material containing large particle sizes. Extremely good tensile strength and tear resistance. Tolerates operating temperatures of 70-80°C. Withstands moderate concentrations of chemicals and oils. Available in three options: smooth, contact layer and tear off.



Trellex TR60

Wear-resistant rubber sheeting for applications where good wear resistance is required. Moderate tensile strength and tear resistance. Genuine all-around sheeting that can be used for the most diverse applications.



Trellex Premium Pink

A rubber lining with outstanding properties in terms of high tensile strength, maximal elongation to break, strong tear resistance and excellent resistance to abrasion and corrosion. Perfect for sliding wear in wet applications.

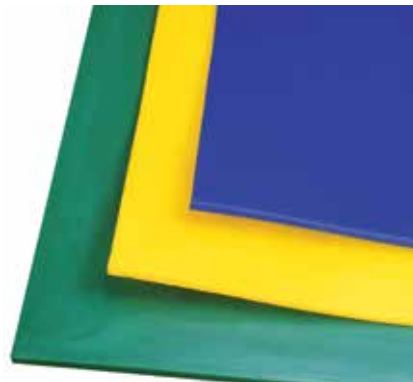

Trellex PU

Plain polyurethane sheeting without reinforcement that can be fastened in several ways in different types of applications. It provides good abrasion resistance to fine and medium sized particles. The polyurethane wear-resistant sheetings has good resistance to oil and very good ozone resistance. Excellent wear resistance especially in wet applications.



Xresist™

Xresist is a high-density, alumina ceramic bead-filled, toughened epoxy system designed to protect equipment from wear and abrasion caused by handling and processing particulate matter in solid or slurry form. It is ideal for use in transfer chutes, feed boxes and sumps.

Trellex RU sheeting - T40

High-quality, black natural rubber (NR), used for sliding abrasion of small particles.

Trellex T40 S (smooth)

Sheeting intended mainly for sliding and blasting abrasion and for small particle sizes. Extremely high wear resistance against fine-grained, slurried materials. Tolerates operating temperatures of 60 – 70°C. Withstands low concentrations of oil (splashing, etc.). Limited resistance to crushing, piercing and tearing.

T40 CL (contact layer)

Same type of rubber as in T40 S. One side is coated with a special contact layer, which eliminates the need for buffing and primer treatment. A single application of adhesive is sufficient. Furthermore, installation is simpler and faster.

T40 TO (tear off)

Same type of rubber as in T40 S. One side with a tear-off fabric backing. Removing the fabric backing exposes a roughened surface free of impurities and suitable for immediate bonding without first needing to be buffed, making the installation easier and faster.

Trellex T40 technical information				
Property	Typical values	Tolerance	Unit	Test method
Color	Black			
Rubber	NR			
Hardness	40	40 ±5	°IRHD	ISO 48
Density	1.0	1.0±0.03	g/cm ³	ISO 2781
Tensile strength	18	16 MIN	MPa	ISO 37
Elongation at break	600	575 MIN	%	ISO 37
Tear resistance ISO 34 C	24	21 MIN	kN/m	ISO 34

Trellex T40 standard range							
Nom. thickness (mm)	Width (mm)	Length (mm)	Nom. weight (kg/m ²)	kg/roll	Trellex T40 S	Trellex T40 CL	Trellex T40 TO
4	1,400	10,000	4.0	56	TX1093450	TX1833250	TX2020620
4	1,400	50,000	4.0	280	TX2246310		
5	1,400	10,000	5.0	70	TX1093468	TX1833260	
6	1,400	10,000	6.0	84	TX1093476	TX1833270	TX718817
6	1,400	50,000	6.0	420	TX2246320		
8	1,400	6,000	8.0	67	TX1093484	TX1833280	TX2125270
10	1,400	6,000	10.0	84	TX1093038	TX2125210	TX2071030
12	1,500	3,000	12.0	54	TX2247270		
15	1,500	3,000	15.0	68	TX2247280		
20	1,500	3,000	20.0	90	TX2247290		
25	1,500	3,000	25.0	113	TX2247300		



Trellex RU sheeting - T60

High-quality, black styrene butadiene rubber (SBR) for use with larger-sized particles. Excellent for wear, tear and impacting applications.

Trellex T60 S (smooth)

A rubber grade satisfying extremely high requirements of wear and tear and of impacting. Outstanding when the abrasive material contains large particle sizes. Extremely good tensile strength and tear resistance. Tolerates operating temperatures of 70 - 80°C. Withstands moderate concentrations of chemicals and oils.

T60 CL (contact layer)

Same type of rubber as in T60 S. One side is coated with a special contact layer, which eliminates the need for buffing and primer treatment. A single application of adhesive is sufficient. Furthermore, installation is simpler and faster.

T60 TO (tear off)

Same type of rubber as in T60 S. One side with a tear-off fabric backing. Removing the fabric backing exposes a roughened surface free of impurities and suitable for immediate bonding without first needing to be buffed.

T60 PR (profile)

Same type of rubber as in T60 S. A profiled top surface for use in applications where the abrasive media has an impact angle between 30° to 60°.



Trellex T60 standard range technical information				
Property	Typical values	Tolerance	Unit	Test method
Color	Black			
Rubber	SBR			
Hardness	60	60 ±5	°IRHD	ISO 48
Density	1.13	1.13±0.03	g/cm ³	ISO 2781
Tensile strength	19.5	17 MIN	MPa	ISO 37
Elongation at break	510	450 MIN	%	ISO 37
Tear resistance ISO 34 C	30	27 MIN	kN/m	ISO 34

Trellex T60 standard range								
Nom. thickness (mm)	Width (mm)	Length (mm)	Nom. weight (kg/m ²)	kg/roll	Trellex T60 S	Trellex T60 CL	Trellex T60 TO	Trellex T60 PR
3	1,400	10,000	3.4	47	TX1034868			
4	1,400	10,000	4.5	63	TX1094185	TX2125010	TX593574	
4	1,400	50,000	4.5	316	TX1094186			
5	1,400	10,000	5.7	79	TX1094193		TX593582	
6	1,400	10,000	6.8	95	TX1017749	TX2125030	TX545947	
6	1,400	50,000	6.8	475	TX2069970			
8	1,400	6,000	9.0	76	TX1017757	TX2125040	TX283226	
10	1,400	6,000	11.3	95	TX1017765	TX1832050	TX545939	
12	1,400	5,000	13.6	95	TX1833150	TX2462401	TX593590	
15	1,400	5,000	17.0	119	TX1833210	TX1832570	TX1451540	
15	1,400	25,000	17.0	593	TX2462416	TX2462417		
15	1,400	35,000	17.0	831	TX2462430			
15	1,400	50,000	17.0	1,187	TX1833212			
20	1,400	5,000	22.6	158	TX1833580	TX2071560	TX593616	
20	1,400	25,000	22.6	791	TX2462418		TX6660457	
20	1,400	50,000	22.6	1,582	TX2462419			
25	1,400	5,000	28.3	198	TX1833590		TX593624	
25	1,400	25,000	28.3	989	TX2462420			
25	1,400	50,000	28.3	1,978	TX2126360			
30	1,400	5,000	33.9	237	TX2462422			
35	1,500	3,000	39.6	178	TX1017814			
35	1,400	25,000	39.6	1,384	TX2462424			
40	1,400	5,000	45.2	316	TX2462425			
50	1,400	25,000	56.5	1,978	TX2462428			
50	1,500	3,000	56.5	254	TX1017822			
15	1,350	3,000	17.0	69				TX1017830
35	1,350	3,000	39.6	160				TX1017848

Trellex RU sheeting - TR60

Black, wear-resistant rubber sheeting for applications where good wear resistance is required. An economic choice for softer rocks and smaller impact forces.

Trellex TR60

Moderate tensile strength and tear resistance. Genuine all-around sheeting that can be used for the most diverse applications.

Trellex TR60 technical information				
Property	Typical values	Tolerance	Unit	Test method
Color	Black			
Rubber	NR/SBR			
Hardness	60	60 ±5	°IRHD	ISO 48
Density	1.25	1.25±0.03	g/cm ³	ISO 2781
Tensile strength	12	10 MIN	MPa	ISO 37
Elongation at break	450	390 MIN	%	ISO 37
Tear resistance ISO 34 C	23	20 MIN	kN/m	ISO 34

Trellex TR60 standard range						
Nom. thickness (mm)	Width (mm)	Length (mm)	Nom. weight (kg/m ²)	kg/roll	Trellex TR 60 S	Trellex TR60 CL
3	1,400	10,000	3.8	53	TX1451603	
4	1,400	10,000	5.0	70	TX1451604	TX2462400
4	1,400	50,000	5.0	350	TX2462440	
5	1,400	10,000	6.3	88	TX1451605	
6	1,400	10,000	7.5	105	TX1451590	TX2462402
6	1,400	50,000	7.5	525	TX2462441	TX2462442
8	1,400	6,000	10.0	84	TX1451608	TX2462403
8	1,400	50,000	10.0	700	TX2462443	TX2462444
10	1,400	6,000	12.5	105	TX1451600	TX2462404
10	1,400	50,000	12.5	875	TX2462445	TX2462446
12	1,400	5,000	15.0	105	TX1451612	
12	1,400	6,000	15.0	126		TX2462405
15	1,400	5,000	18.8	131	TX1451610	TX2462406
15	1,400	25,000	18.8	656	TX2462448	TX2462449
20	1,400	5,000	25.0	175	TX1694480	TX2462407
20	1,400	25,000	25.0	875	TX2462451	TX2462452
20	1,400	50,000	25.0	1750	TX2462453	
25	1,400	5,000	31.3	219	TX1451625	
25	1,400	25,000	31.3	1094	TX2462454	TX2462455
30	1,400	5,000	37.5	263	TX2462456	
35	1,500	3,000	43.8	197	TX1451635	
40	1,400	5,000	50.0	350	TX2462457	
50	1,500	3,000	62.5	281	TX1451650	

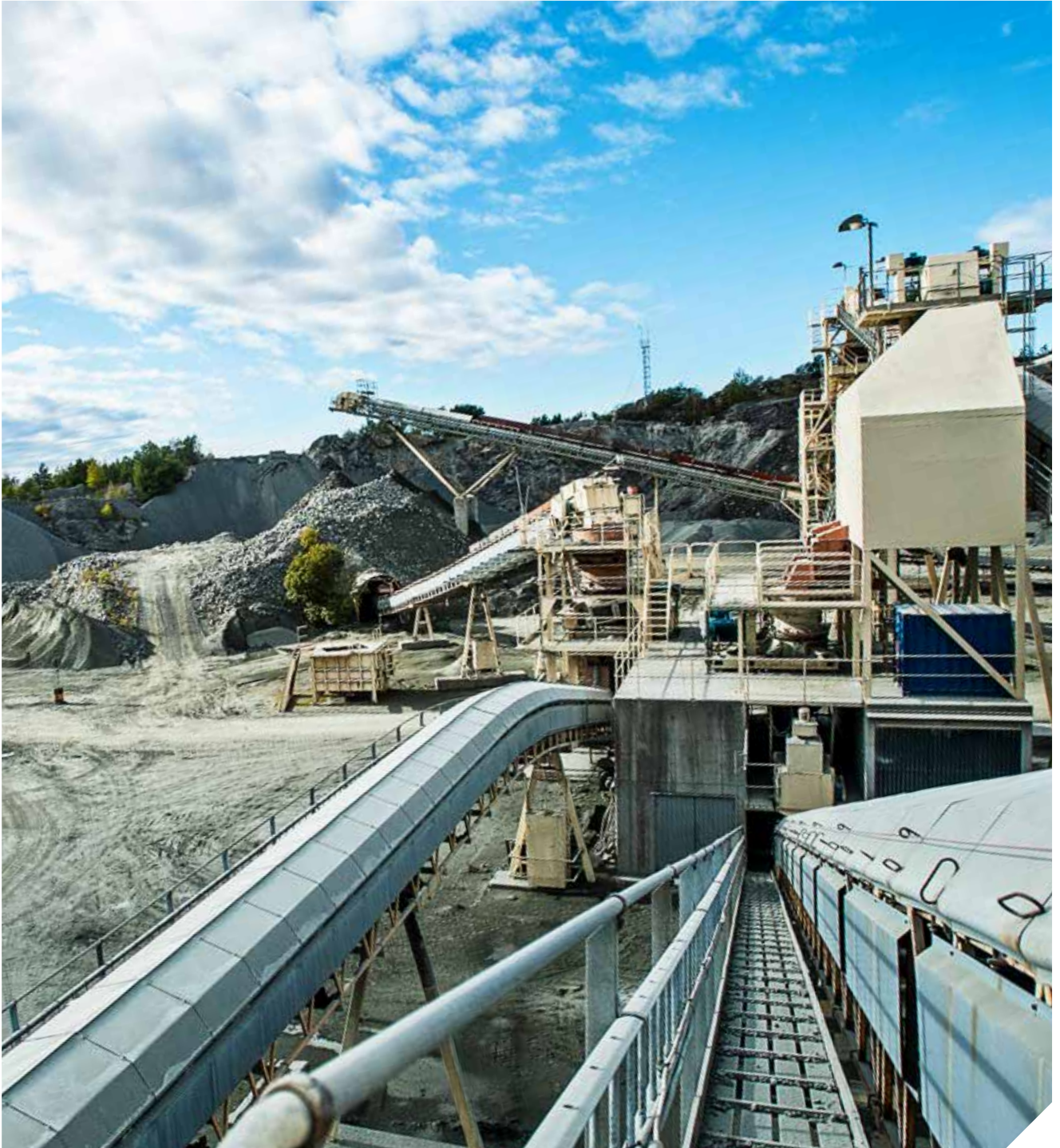

Trellex Premium Pink™

A wear-resistant lining in natural rubber. For demanding and abrasive wet applications.

Outstanding properties

Trellex Premium Pink is ideal for use in both wet and dry applications. Its mechanical characteristics showcase outstanding properties in terms of high tensile strength, maximal elongation at break, strong tear resistance and excellent resistance to abrasion and corrosion. All of these properties add up to longer service intervals and reduced downtime. Due to the rubber's noise and vibration dampening qualities, noise pollution decreases with the installation of Premium Pink, thereby improving the working environment.

Trellex Premium Pink is available in different thicknesses, with a contact layer (CL) or with smooth surface (S).



A very versatile solution

Trellex Premium Pink is a natural rubber lining that can be utilized in a wide range of applications, e.g. hoppers, cyclones, vibrating lines, extraction pump bodies, tanks, and silos. Trellex Premium Pink is available in different thicknesses and with either a smooth surface or with a contact layer that eliminates the need for buffing and primer treatment, making installation safer, faster, and easier.

Trellex Premium Pink S (smooth)

A natural pink rubber for most demanding wet applications within the mining, aggregates, and other industries. Its physical properties are among the best in the industry. A flexible material with outstanding performance in handling wet and sticky material; and tolerates operating temperatures from -40°C - 80°C, withstanding diluted acids and bases.

Trellex Premium Pink CL (contact Layer)

The same type of rubber as in the smooth but with one side coated with a special contact layer, Eliminating the need for buffing and primer treatment. A single application of adhesive is sufficient.



Trellex Premium Pink technical description

Property	Typical values	Tolerance	Unit	Test method
Color	Red			
Rubber	NR			
Hardness	35	35 ±5	Shore A	ISO 868
Density	0.95	0.95±0.05	g/cm ³	UNE53526
Tensile strength	≥25	25 Min	MPa	ISO 37
Elongation at break	≥700	700 Min	%	ISO 37
Tear resistance	≥30	30 Min	N/mm	ISO 34-1
Abrasion resistance (5N)	≤60		mm ³	ISO 4649
Compression set after 22h at 70°C	≤30		%	ISO 815-1
Operating temperature	-40/80		°C	

Trellex Premium Pink standard range

Nom. thickness (mm)	Width (mm)	Length (mm)	Nom. weight (kg/m ²)	kg/roll	Premium Pink S	Premium Pink CL
3	1,500	10,000	2.9	44	TX2562461	TX2562465
6	1,500	10,000	5.8	87	TX2562462	TX2562466
10	1,500	10,000	9.7	146	TX2562463	TX2562467
12	1,500	10,000	11.6	175	TX2562464	TX2562468
20	1,500	10,000	19.4	291	MM1575335	TX2562469

Adhesive systems

Our objective is to help you protect your expensive conveying equipment and extend its service life. Metso Outotec adhesive systems, consisting of primer and glue, support this ambition by making it possible to securely line vulnerable steel or rubber surfaces with an additional layer of protective rubber.

Trellex Steelprimer P5

Trellex Steelprimer P5 is used between rubber and metal before cold-bonding. Trellex Steelprimer P5 improves the adhesion between rubber and metal and also protects the metal surface from rust.

Material properties

To get a good bonding surface, there is no substitute for this tried and tested steel primer. P5 was developed to work optimally with Greenbond adhesive. When the two products are used together the result is a bond with the absolute maximum strength.

Special features

Greenbond is free from trichloroethylene and its associated health risks.

Application

Rubber to metal.

Practical tips for use

- Trellex Steelprimer is highly flammable and must not be used underground or in closed spaces
- The steel surface can be prepared (sandblasted, cleansed and primed) in advance as long as it's protected from dust and dirt while waiting to be glued

Trellex Steelprimer P5 technical information	
Property	
Density	0.85g/cm ³
Color	Black
Consumption	0.20 l/m ²

Trellex Steelprimer P5 standard range		
Part no.	Description	Weight (kg)
2322060	Trellex adhesives Steelprimer P5 (0.75 L)	0.7

Trellex Greenbond

The Trellex Greenbond is a strong, reliable adhesive for gluing rubber to steel or rubber to rubber. When attaching sheeting, it is important to have a secure bond between the two materials, to increase availability of capital equipment and enable a smooth-running, problem-free production.

Material properties

Greenbond gives a strong bond between any rubber and steel surface or even two rubber surfaces. When rubber is glued down with Greenbond, it adheres tightly to the contact surface, thereby minimizing damage to your capital equipment.

Special features

Greenbond is free from trichloroethylene and its associated health risks.

Practical tips for use

- To avoid crystallization of the chloroprene in the rubber compound, be sure to store the solution above 6 °C. It is also important for Trellex Greenbond to be at room temperature before using it in order to maximize bond strength
- We recommend waiting at least 24 hours, for reaching full strength of the bond
- The drying time varies depending on factors such as humidity and air temperature
- Trellex Greenbond is highly flammable and must not be used underground or in closed spaces

Trellex Greenbond technical information

Property	
Material	Polychloroprene rubber
Solvents	Ethyl acetate/naphtha/acetone
Density	0.8g/cm ³
Color	Black
Pot life	Approx. 3-5 hours
Consumption	0.35 l/m ²
Shelf life	18 months at room temperature, after date of production

Trellex Greenbond standard range

Part no.	Description	Weight (kg)
2322040	Trellex adhesives Greenbond (0.8 l) incl. hardener	0.7
2322041	Trellex adhesives hardener gb (40 g)	1.1
2322042	Trellex adhesives greenbond (0.8 l)	0.6

Trellex PU

Polyurethane wear-resistant sheeting for small and sliding particles. Excellent oil and solvent resistance. Available in thicknesses from 5 mm to 30 mm in a standard dimension of 1,000 x 2,000 mm.

Wear-resistant polyurethane sheeting

Trellex PU is a plain polyurethane sheeting without fabric or steel reinforcement. It can be fastened in several ways in different types of applications. It provides good abrasion resistance to fine- and medium-sized particles. The PU wear-resistant sheeting typically has good resistance to oil and very good ozone resistance as well as excellent wear resistance especially in wet applications. It is available in the same sizes but in different hardnesses: 70°, 80° and 90° IRH. The lining can be tailor-made out of standard sheets to fit different applications.



Trellex PU sheeting standard range technical information			
Property	PU70	PU80	PU90
Hardness (°IRH)	70 ± 5	80 ± 5	90 ± 5
Tensile strength (MPa)	Min 30	Min 35	Min 35
Elongation at break (%)	Min 400	Min 400	Min 350
Tear resistance ISO 34C (kN/m)	Min 30	Min 40	Min 55
Density (Mg/m ³)	1.19 ± 0.02	1.20 ± 0.02	1.21 ± 0.02
Color	Blue	Yellow	Green

Trellex PU sheeting standard range technical information					
Nom. thickness (mm)	Approx. width (mm)	Approx. length (mm)	Shore A 70° Blue	Shore A 80° Yellow	Shore A 90° Green
5	1,000	2,000	TX690005-70	TX690005-80	TX690005-90
10	1,000	2,000	TX690010-70	TX690010-80	TX690010-90
15	1,000	2,000	TX690015-70	TX690015-80	TX690015-90
20	1,000	2,000	TX690020-70	TX690020-80	TX690020-90
25	1,000	2,000	TX690025-70	TX690025-80	TX690025-90
30	1,000	2,000	TX690030-70	TX690030-80	N/A

Xresist™ wear compound

Metso Outotec Xresist™ is a high-density, alumina ceramic bead-filled, toughened epoxy system designed for protecting equipment from wear and abrasion.

Applications

- Sumps
- Pipes
- Slurry pumps
- Scrubbers
- Screens
- Mills
- Screw conveyors
- Chutes
- Cyclones
- Coal handling equipment
- Dust handling equipment
- Launderers



Xresist ceramic epoxy wear compound	
Part no.	Kit size
W20867	5 kg

Features

- Fast cure with good pot life
- Service temperatures to 120°C
- Trowelable, finish with water to create a smooth surface
- Outstanding resistance to a wide range of chemicals
- Applies easily to vertical surfaces
- Excellent adhesion to most metals, ceramics, concrete and other surfaces

Technical specifications

- Pot life 5 minutes @ 24°C
- Functional cure 3 hours @ 24°C
- Full cure 16 hours @ 24°C
- Note: cure times will be faster at higher temperatures
- Shelf life, minimum 2 years when stored in a cool dry place

Estimated usage

5 kg Metso Outotec Xresist = 0.39 m² @ 6 mm thick



Attachment systems

Attachment systems

Choosing Metso Outotec liners gives you access to our unique attachment systems that work together with our liner handling systems to simplify the installation and removal of your liners. Whether you are looking to decrease downtime through the use of wear side only attachments, reduce the number of fasteners, replace studs or eliminate hot works, we have a product to suit your needs.





EzyLock™

Improve safety and uptime with the patented Metso Outotec EzyLock fastener that enables liner change-outs to be conducted from the easy-to-access wear side only. EzyLock is compatible with the SafeFit handling system and features a simple removal process that eliminates the need for hot works.



Taper-T™

The unique Taper-T wear side only attachment system eliminates the need for traditional studs and nuts, enabling faster, safer and simpler wear plate change-outs. The ability to use the SafeFit handling system combined with the high-strength of the fasteners enables a shift to broadsheet liners, which can significantly reduce downtime.



CeramicTT™

CeramicTT incorporates the benefits of the Taper-T wear side attachment system with the prolonged wear life of a ceramic liner. It is ideal for applications where access to the rear of the chute is limited or difficult as it provides all the advantages of a wear side only attachment system.



Xlok™

Metso Outotec Xlok is a tough modular liner system and the ultimate choice for situations where equipment can only be accessed from the inside or where a single-sided bolting system provides maintenance savings. Xlok delivers consistent liner position on all four sides with no guesswork or measuring to install, as the backplate automatically spaces the liners.



TaperLock

TaperLock is designed to replace weld-on studs with a high-strength fastener that enables a reduction in bolting intensity by up to 50%. When used on thicker liners, TaperLock also facilitates the use of the SafeFit handling system to make liner installation and removal quicker and safer.



D-Lock™

D-Lock features a unique D-shaped head that prevents the bolt from rotating when installing or removing the nut. The high-strength bolt enables a reduction in the number of fasteners and is compatible with the SafeFit handling system, which enables larger liners to be safely installed and removed.



RemLock™

The patented RemLock features a unique nylon cover that fully encapsulates and protects the exposed bolt thread. This makes nut removal faster and safer, removing the need for hot works. RemLock can be used with standard bolts and studs, or combined with TaperLock or D-Lock to further enhance the benefits of these systems.



EzyLock™

EzyLock is a single-sided fastener designed for use with metallic and polymer wear liners. It features a unique locking mechanism that is activated and deactivated through the head of the fastener, enabling liners to be installed and removed from the wear side only.

- Wear side only fastener suitable for all types of metallic and some polymer liners
- Removes the need for external scaffolding or access to the outside of the chute
- The head is installed flush with the wear surface to reduce preferential wear
- High-strength tapered bolt head maintains clamping force throughout wear life cycle
- Compatible with the SafeFit™ handling system, enabling larger/fewer liners to be used
- Fewer fasteners combined with wear side only installation leads to reduced downtime



Application areas

EzyLock fasteners are ideally suited to liner installations where access to the external walls of the chute is difficult or undesirable; however, they can also be used on any asset where minimizing downtime can lead to increased productivity. Installation examples include coarse ore stockpile hoppers, ROM bins and train loadout chutes.

Materials

The EzyLock attachment system is primarily designed for use with any metallic or polymer wear liner material and has been successfully installed in Q&T plate, weld overlay, cast metal and polymer liners. The high-strength and large shear area of these fasteners makes them particularly suited for broad sheet weld overlay or heavy cast liners, which also exploit the benefits of the SafeFit handling system. For correct installation, the EzyLock requires a minimum combined liner and wall thickness of 22 mm.

Technical description

EzyLock fasteners are manufactured from high tensile steel that has been hardened to match the wear rate of the liner. The EzyLock body comes preassembled; however, the activation pin and insert are supplied loose to facilitate installation.

Naming convention

EzyLock fasteners are available for a wide variety of liner and wall thickness combinations. When ordering, please use the following naming convention:

EL X/Y

Where:

EL = EzyLock

X = Liner thickness

Y = Wall thickness

Note:

The minimum wall thickness is 6 mm ($Y \geq 6 \text{ mm}$).

The combined liner and wall thickness must be at least 22 mm ($X + Y \geq 22 \text{ mm}$).

Installation and removal

Specialized tooling is required for the installation and removal of EzyLock fasteners. To install an EzyLock fastener, the activation pin is inserted into the chuck on the installation tool, which is then screwed into the head of the EzyLock. The hydraulic cylinder on the installation tool forces the activation pin into the body, extending the three balls that lock the fastener in place. The chuck is unscrewed from the EzyLock and the insert is screwed into the head. The hole in the insert is then filled with silicone to prevent the ingress of ore.

EzyLock fasteners can be quickly and easily removed using a customized drive pin and pneumatic pin driver. The drive pin is inserted through the hole in the EzyLock head, and the pneumatic pin driver is used to force the activation pin through to the back of the EzyLock body. This releases the three balls within the EzyLock, allowing the stainless steel sleeve to slide off the back. The EzyLock can then be withdrawn from the front of the liner.

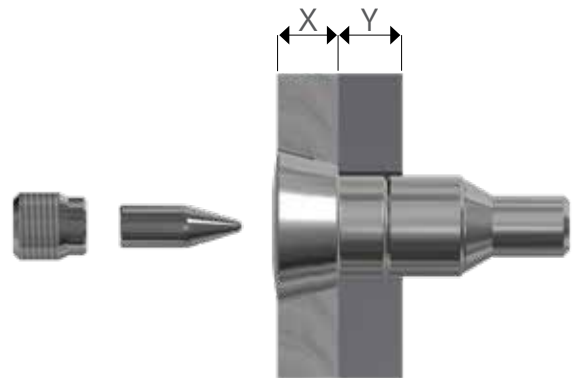

Installation and removal tools for EzyLock fasteners

Part no.	Description	Included Components
ZX11860652	DWPS-ACTKIT	Hydraulic power pack, hose, cylinder, adaptor, carry case (activation heads not included)
Varies*	DWPS-AT-X/Y	Activation head (the head size must match the corresponding EzyLock fastener size)
ZX11861481	DWPS-PPD-CP9CS-RHD	Pneumatic pin driver supplied with two standard length drive pins, carry case
ZX11860960	DWPS-DP	Spare drive pin for pneumatic pin driver (standard-length)
ZX11860963	DWPS-DP-XL	Spare drive pin for pneumatic pin driver (extra long)
ZX11861461	DWPS-POD-EL	SafeFit podgy bar to suit EzyLock attachment system
ZX11860939	DWPS-CT-EL	SafeFit clamping tool to suit EzyLock attachment system
ZX11861515	DWPS-SC1000-40	SafeFit scissor clip lifting device (1,000 kg WLL) to suit 40 mm tapered hole

* The part number for the activation head varies depending on the size of the EzyLock fastener on which they will be used. When ordering an activation head, use the description DWPS-AT-X/Y, where X is the liner thickness and Y is the wall thickness.

Other information

- Some clearance is required on the back wall of the chute to accommodate the rear portion of the EzyLock
- During removal, the expanded sleeve will remain on the outside of the chute when the EzyLock is withdrawn from the liner. A clear drop zone should be maintained below the chute to allow for this sleeve as it falls (the sleeve mass is <30 g)
- A capsule system is available to enable EzyLock fasteners to be used in chutes that are embedded in concrete. Please contact Metso Outotec for details

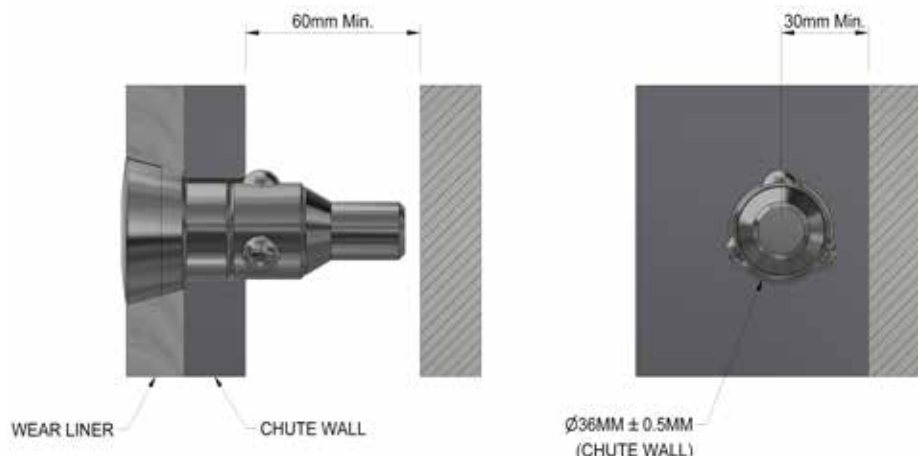

Scan the QR code or click here to visit the Metso Outotec website for a video showing the EzyLock installation and removal process.

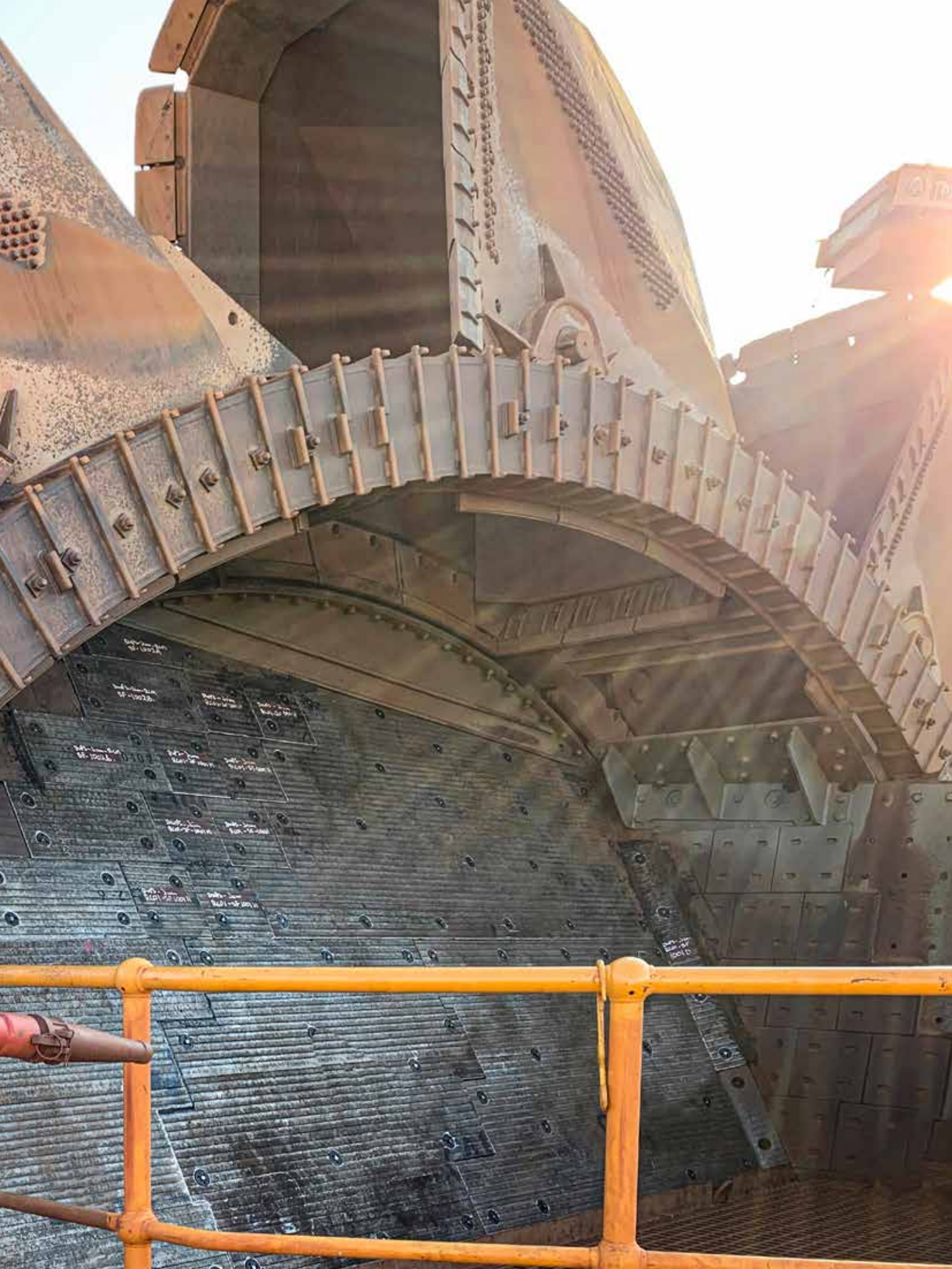

Taper-T™

Taper-T is a single-sided fastener designed for use with metallic and polymer wear liners (for ceramic liners, please refer to CeramicTT). It incorporates a number of patented features to simplify the installation and removal process, making it one of the easiest wear side only fastener systems available.



- Wear side only fastener suitable for all types of metallic and hard polymer liners
- High-strength tapered bolt head ensures liner is secured throughout wear life cycle
- The installation tool is compatible with standard impact and torque wrenches
- Larger/fewer liners can be used when utilizing the SafeFit handling system
- Removes the need for external scaffolding or access to the outside of the chute
- The head is installed flush with the wear surface to reduce preferential wear



Liners being installed using the Taper-T attachment system.



Taper-T attachments in service showing minimal preferential wear.

Application areas

Taper-T fasteners are primarily designed for use in chutes where access to the external walls is limited or difficult. Typical applications include the spill face on bucket wheel reclaimers, car dumper hoppers and large storage or feed bins. The ability to use the SafeFit handling system when utilizing Taper-T attachments means that liner packages can often be re-designed to minimize the number of wear plates and fasteners, which can significantly reducing the shutdown time required to change the liners. If Taper-T fasteners are specified for new installations, the equipment can be designed without the requirement to provide access to the outside of the chute thereby reducing the complexity and cost of the plant.

Materials

Taper-T is suitable for use with any metallic or polymer wear liner material and has been successfully installed in Q&T plate, weld overlay, cast metal and polymer liners. The minimum recommended chute wall thickness is 6 mm and the maximum recommended liner thickness is 32 mm. The only requirement is that it must be possible to make a tapered hole in the liner to match the head of the Taper-T. This can normally be done when the liners are being cut or cast without requiring additional processing (although machining may be required for polymer liners). CeramicTT is a variant of the Taper-T fastener and can be used for ceramic liners or any other type of liner that incorporates a mild steel backing plate. Please refer to the CeramicTT section for additional information.

Technical description

The Taper-T fastener consists of two main components, the wear-resistant head and the T-nut. The wear-resistant head resides in the countersunk holes of the wear liner and is designed to wear at the same rate as the liner. The T-nut engages with the slot in the wall and holds the liner in place. Taper-T has a nylon anti-seize cup that lowers the friction during installation and removal while also physically separating the Taper-T head from the wear liner to prevent any potential bonding. The nylon locating flange ensures that the T-nut engages with the slot in the wall for easier installation.

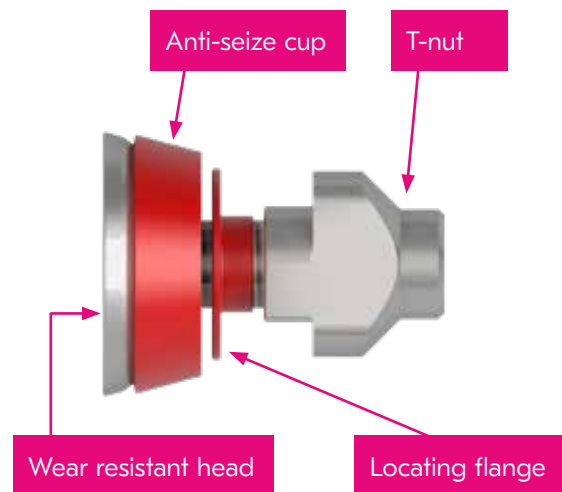

Taper-T bolt - mechanical properties

Bolt Size	Cross-sectional area (across thread)	Ultimate yield strenght	Ultimate tensile strenght	Max. permissible tensile stress	Max. permissible tensile load	Max. permissible shear stress	Max. permissible shear load
M16 grade 8.8	144 mm ²	660 MPa	830 MPa	374 Mpa	54 kN	208 MPa	30 kN

Naming convention

Taper-T fasteners are available for a wide variety of liner and wall thickness combinations. When ordering, please use the following naming convention:

Taper-T X/Y

Where:

X = Liner thickness

Y = Wall thickness

Note:

The minimum wall thickness is 6 mm ($Y \geq 6 \text{ mm}$)

The maximum recommended liner thickness is 32 mm ($X \leq 32 \text{ mm}$)

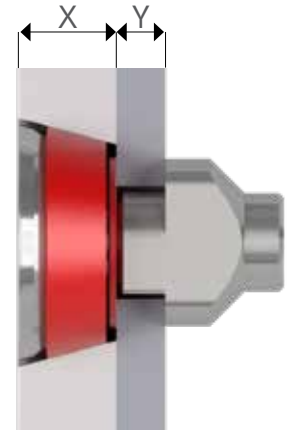

Installation and removal

Taper-T fasteners are installed and removed using a proprietary 3-Pin drive tool which fits a standard 1/2" impact wrench and engages with the 3 holes in the head of the Taper-T. The position of the head and locating flange are pre-set to facilitate installation. To install, the head is positioned on the 3-Pin drive and the Taper-T is inserted through the liner and chute wall. When the 3-Pin tool rotates, the Taper-T will lock into the slot in the wall and the head will then pull the liner against the wall as the tool continues to be rotated. As the holes in the head of the Taper-T go almost all the way through, the same 3-Pin drive tool can be used to remove the Taper-T when the liner has worn.



Installation and removal tools for Taper-T fasteners

Part no.	Description	Included components
ZX11860644	DWPS-DP	3-Pin drive tool to suit 1/2" drive impact wrench
ZX11860950	DWPS-CT-TT	SafeFit clamping tool to suit Taper-T attachment system
ZX11861473	DWPS-POD-TT	SafeFit podgy bar to suit Taper-T attachment system
ZX11861515	DWPS-SC1000-40	SafeFit scissor clip lifting device (1,000 kg WLL) to suit 40 mm tapered hole



Scan the QR code or click here to visit the Metso Outotec website for a video showing the Taper-T installation and removal process.

Slot-cutting tool kit

To function correctly, Taper-T requires a slot in the chute wall. This slot would normally be made when manufacturing the chute; however, if retrofitting the Taper-T system to an existing chute it will be necessary to convert the existing liner bolt holes in the chute wall to slots. Metso Outotec produces a slot-cutting tool kit that can be used to facilitate the conversion process. The slot-cutting tool kit includes a plasma cutter that is magnetically secured to the chute wall and follows a pre-defined template to accurately cut a slot centered around an existing hole. The slot-cutting tool kit is available for hire from Metso Outotec.

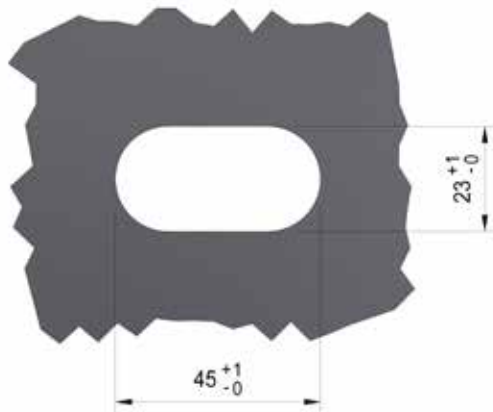

Slot dimensions

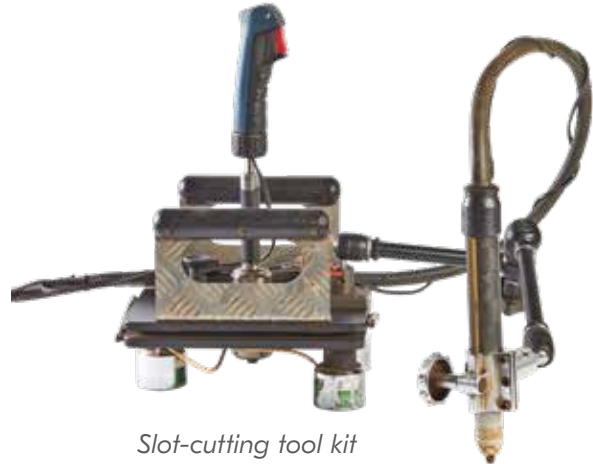

Slot-cutting tool kit

Other information

- Some clearance is required on the back wall of the chute to accommodate the rear portion of the Taper-T fastener
- When installed correctly, the line marked on the Taper-T stud should be vertical
- The pin drive holes in the head of the Taper-T should be filled with silicone after installation to prevent the ingress of dirt and to aid removal. These should be cleaned out with an 8-mm drill prior to removal to ensure good engagement of the 3-Pin drive tool

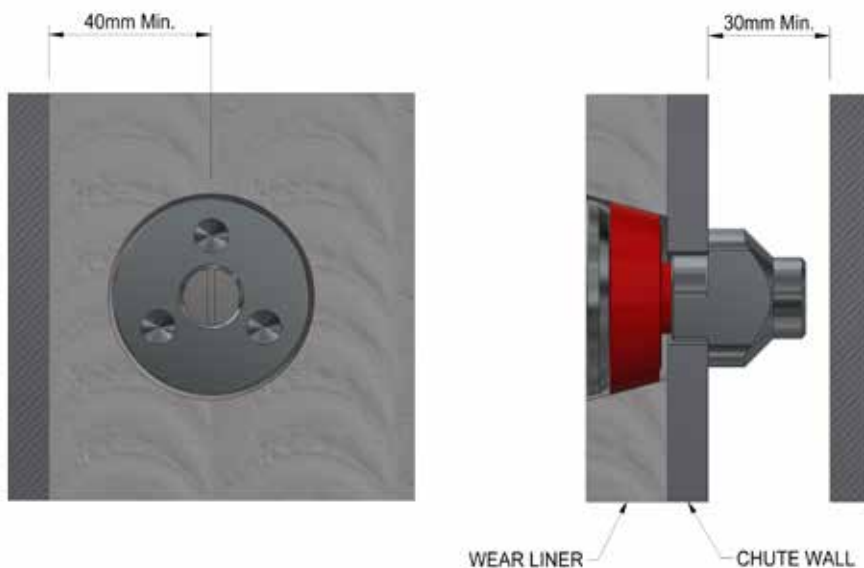

Optional wear monitoring

The Taper-T attachment can also be supplied with an integrated wear sensor to enable continuous monitoring of the remaining liner thickness (refer to the wear monitoring section for further information).



Scan the QR code or click here to visit the Metso Outotec website for a video showing the Taper-T installation and removal process.

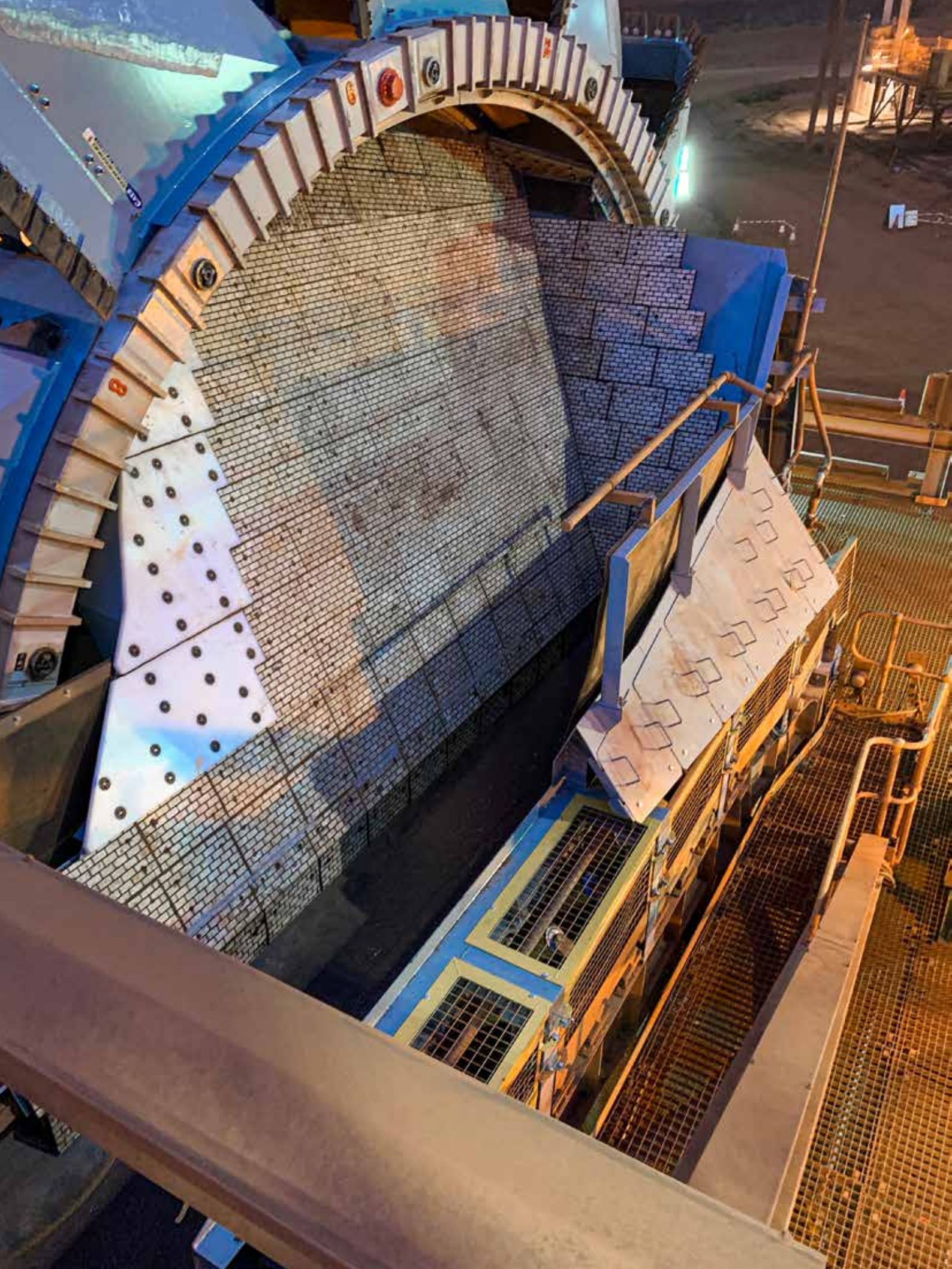

CeramicTT™

CeramicTT is a single-sided fastener designed for use with ceramic and other non-metallic wear liners that incorporate a metallic backing plate. It enables the wear-resistant properties of composite materials to be combined with the benefits of a wear side only attachment system.



- Wear-side only fastener suitable for ceramic and other composite materials
- Only requires an M10 Allen key for installation (can be used with an impact wrench)
- Removes the need for external scaffolding or access to the outside of the chute
- SafeFit lifting device available to safely handle larger liners

Application areas

The CeramicTT can be used in any fixed plant assets, but is ideally suited to areas where accessing the external walls is difficult or undesirable. The only requirement is that the chute wall must incorporate a slot at each fastener location to accommodate the locking mechanism. Installation examples include coarse ore stockpile hoppers, train loadout chutes and the spill face on bucket wheel reclaimers.

Materials

Although specifically designed for use with Ceramic wear liners, the CeramicTT is also suitable for use with other composite materials that incorporate a metallic backing plate. The only prerequisite is that the wear surface must have a hole to accommodate the 10 mm Allen key used to install the fastener.

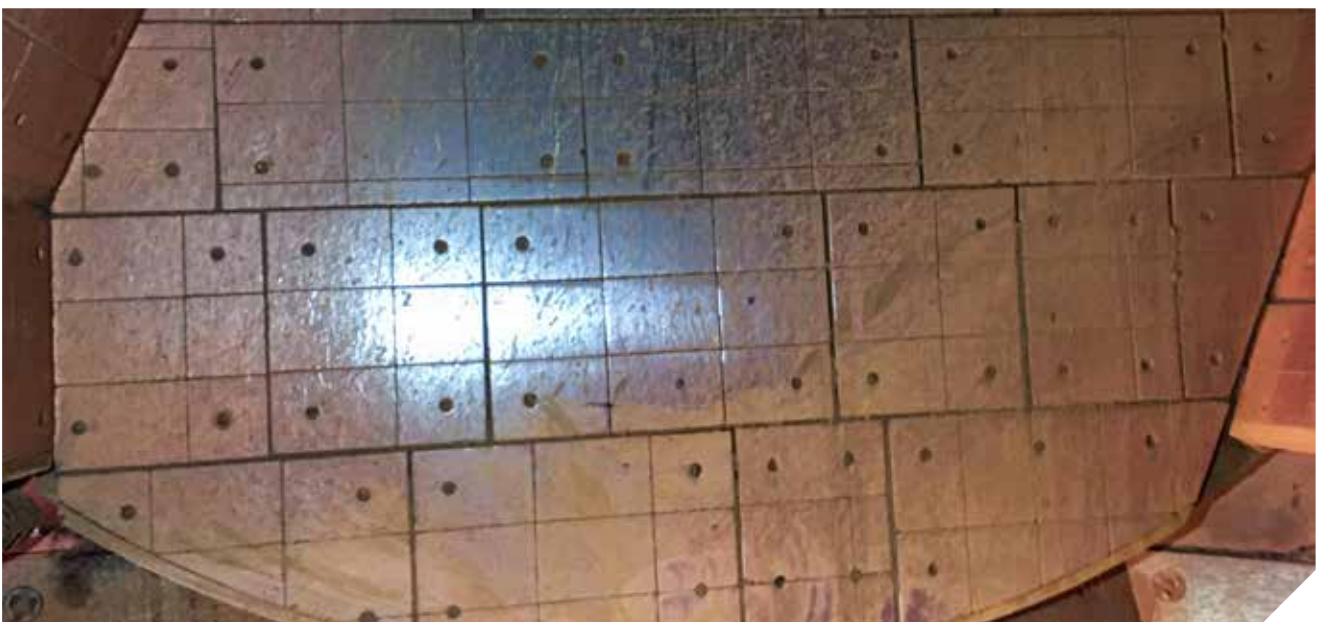

Naming convention

The CeramicTT fastener can be designed for a wide variety of liner and wall thicknesses. The naming convention is as follows:

CTT Y

Where:

CTT = CeramicTT

Y = Wall thickness

Note:

The minimum wall thickness is 6 mm ($Y \geq 6 \text{ mm}$)

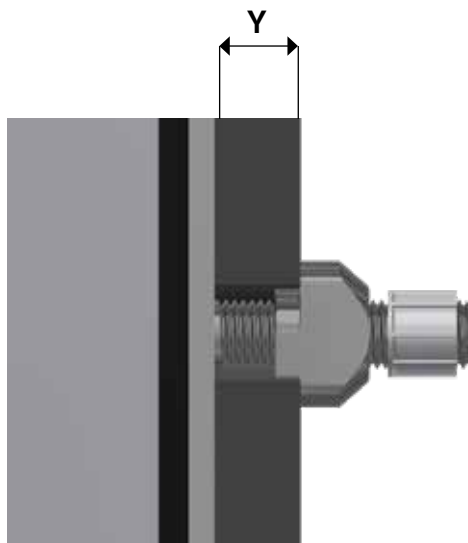

Installation and removal

Liners incorporating CeramicTT attachments can be installed and removed using a standard 10 mm Allen key. Impact sockets incorporating an Allen key can be used with an impact wrench to simplify installation and removal.

Lifting points

Larger CeramicTT liners can be supplied with integrated lifting points to facilitate installation. Each lifting point has a WLL of 500 kg and does not protrude from the back of the liner, allowing it to be positioned flat against the chute wall. The lifting points can only be used to lift the liners into position and do not serve as attachment points to secure the liner against the chute wall.

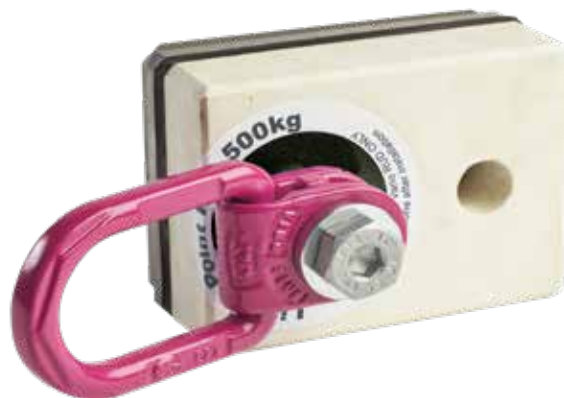

Installation and removal tools for CeramicTT fasteners

Part No.	Description
ZX11861797	Lift Point for ceramic liner (integrated in the liner)
ZX11861801	M12 Rud Lug to suite 37mm thick ceramic liner
ZX11861805	M12 Rud Lug to suite 63mm thick ceramic liner
ZX11898448	Allen key (10mm x 50 long) with 1/2" drive, recommended for 32mm thick liners
ZX11897850	Allen key (10mm x 75 long) with 1/2" drive, recommended for 37mm thick liners
ZX11897848	Allen key (10mm x 100 long) with 1/2" drive, recommended for 63mm thick liners
ZX11898449	Allen key (10mm x 150 long) with 1/2" drive, recommended for 112mm thick liners

Notes:

1. The Lift Point must be specified when ordering the liners.
2. The Rud Lug is re-usable but must be matched to the liner thickness.

Slot-cutting tool kit

To function correctly, CeramicTT requires a slot in the chute wall. This slot would normally be made when manufacturing the chute; however, if retrofitting the CeramicTT system to an existing chute it will be necessary to convert the existing liner bolt holes in the chute wall to slots. Metso Outotec produces a slot-cutting tool kit that can be used to facilitate the conversion process. The slot-cutting tool kit includes a plasma cutter that is magnetically secured to the chute wall and follows a pre-defined template to accurately cut a slot centered around an existing hole. The slot-cutting tool kit is available for hire from Metso Outotec.

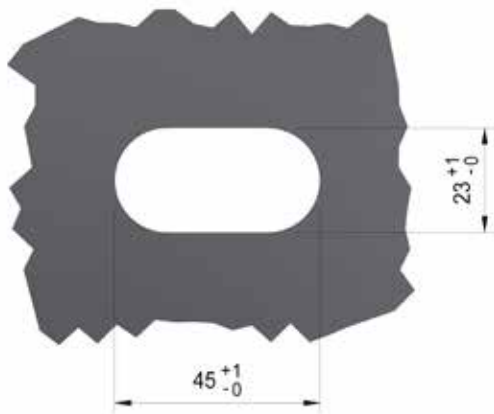

Slot dimensions

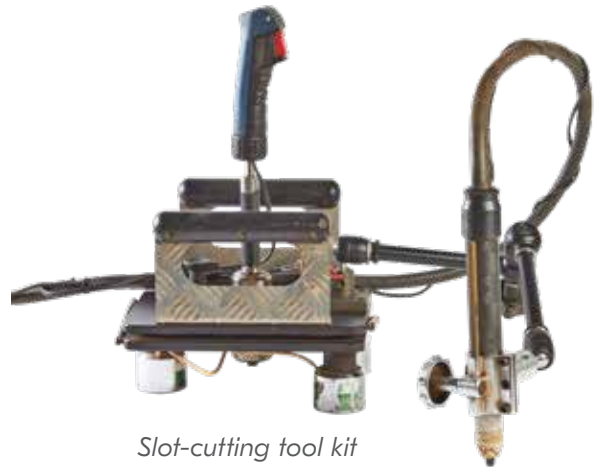

Slot-cutting tool kit

Other information

- Some clearance is required on the back wall of the chute to accommodate the rear portion of the CeramicTT fastener
- The holes on the surface of the liner should be filled with silicone after installation to prevent the ingress of dirt and to aid removal

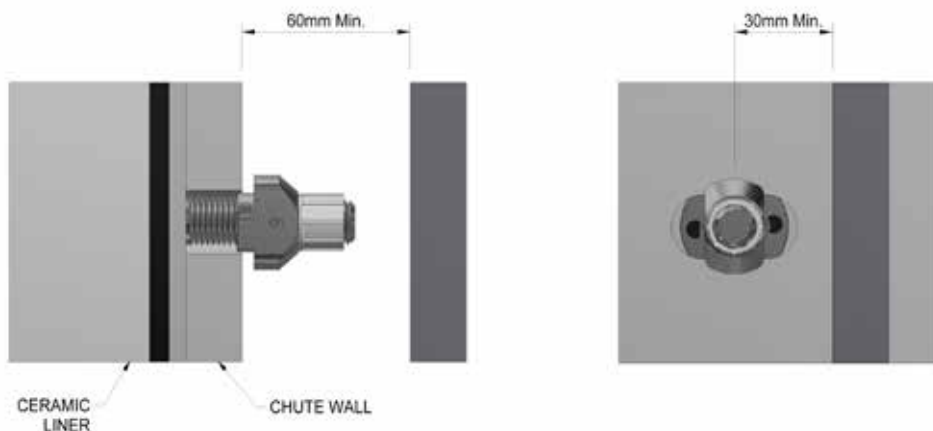

Option for wear monitoring

Wear sensors are also available for liners that utilize the CeramicTT attachment system. However, it should be noted that the wear sensors do not act as a fastener and are designed only to monitor the remaining thickness of the liner.



Xlok™ liner system

Metso Outotec Xlok is an innovative, modular, single-sided wear liner system, ideal for applications where access is limited to one side only. The simple installation and alignment of the steel mounting plate makes liner installation quick and consistent. The modular system allows individual liners to be replaced without removal of surrounding liners. Metso Outotec Xlok uses a standard screw to secure the liner onto the welded backing plate and uses this backing plate to take the load and support the liner in place.

- Modular design
- Single-sided applications
- Industry standard part sizing

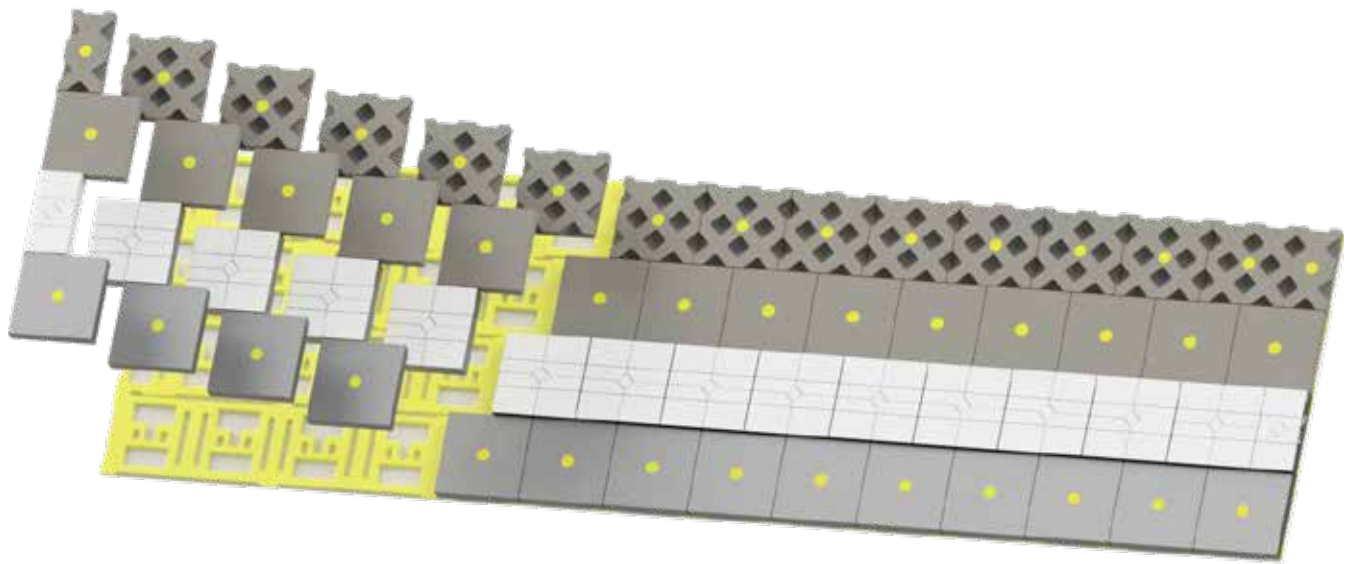

Choice of materials

- High chrome cast iron
- Xalloy plate
- Rubber-bonded ceramics, Poly-Cer
- Rubber-bonded metallics, Polymet
- Abrasion-resistant rubber

Installation

Metso Outotec Xlok eliminates the requirement to have a gap to drop the liner into place. Just fit the liner plate onto the Xlok backing plate and it's in the right place.

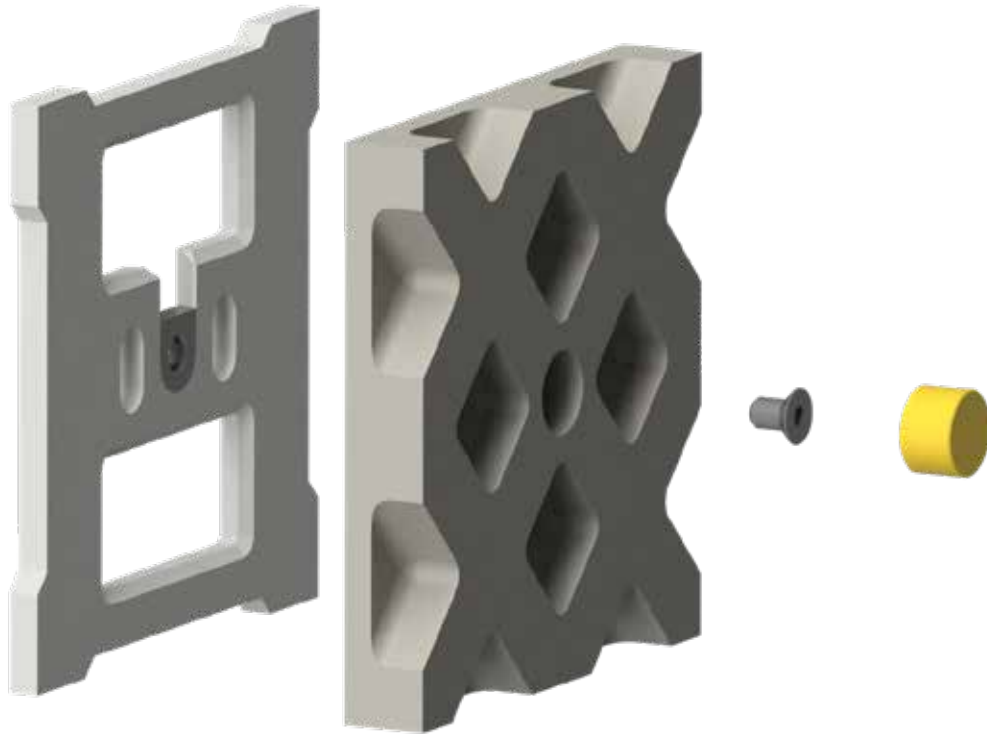

Metallic Xlok liner standard part assemblies			
Part no.	Description	Dimensions (WxLxT) mm	Mass (kg)
ZX11713441	Xlok Cast - Rock Box	300 x 300 x 45	25.16
ZX11712895	Xlok Cast - Rock Box	300 x 150 x 45	13.40
ZX11709147	Xlok Cast - Plain	300 x 300 x 25	18.97
ZX11767461	Xlok Cast - Plain	300 x 300 x 45	31.68
ZX11709059	Xlok Cast - Plain	300 x 300 x 50	35.06
ZX11815652	Xlok Cast - Plain	300 x 300 x 100	45.50
ZX11709224	Xlok Cast - Plain	200 x 300 x 50	23.74
ZX11709042	Xlok Cast - Plain	176 x 300 x 50	20.40
ZX11709151	Xlok Cast - Plain	150 x 300 x 25	9.89
ZX11767460	Xlok Cast - Plain	150 x 300 x 45	16.08
ZX11708534	Xlok Cast - Plain	150 x 300 x 50	17.75
ZX11767459	Xlok Cast - Plain	100 x 300 x 25	6.68
ZX11709063	Xlok Cast - Plain	100 x 300 x 45	10.48
ZX11767468	Xlok Cast - Plain	100 x 300 x 50	11.82

*Each liner assembly includes the liner and the fastener components. The backing plate is supplied separately.

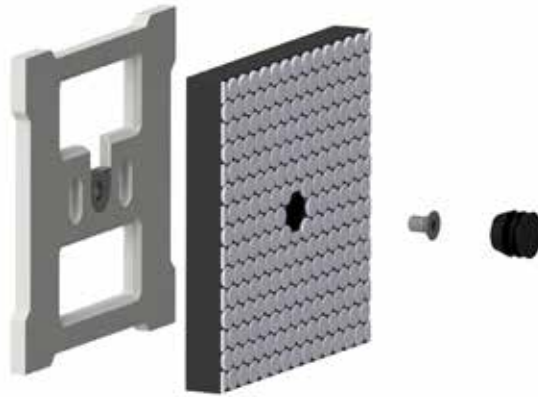

Poly-Cer Xlok liner standard part assemblies

Part no.	Description	Dimensions (WxLxT) mm	Mass (kg)
MM1727190	Xlok PC X92 64 mm	300 x 300 x 64	25
MM1727798	Xlok PC X92 64 mm	300 x 150 x 64	12
MM1529321	Xlok PC 20S 64 mm	300 x 300 x 64	17
MM1529820	Xlok PC 20S 64 mm	300 x 150 x 64	8.3
MM1540146	Xlok PC 20S 64 mm	300 x 100 x 64	5
MM1513930	Xlok PC 20S 40 mm	300 x 300 x 40	9.7
MM1513990	Xlok PC 20S 40 mm	300 x 150 x 40	4.7
MM1539812	Xlok PC 20S 40 mm	300 x 100 x 40	2.8

*Each liner assembly includes the liner and the fastener components. The backing plate is supplied separately.

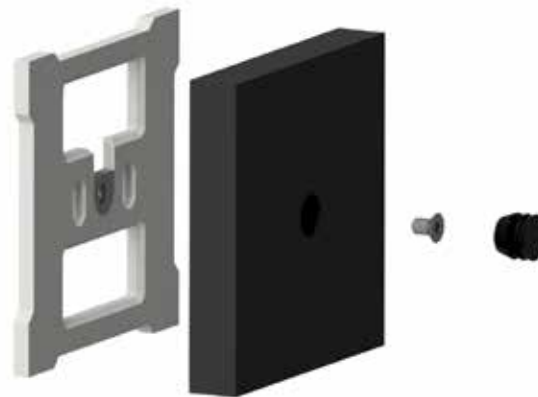

PP element Xlok liner standard part assemblies

Part no.	Description	Dimensions (WxLxT) mm	Mass (kg)
MM1504648	Xlok PP 50 mm	300 x 300 x 50	7.3
MM1504689	Xlok PP 50 mm	300 x 150 x 50	3.5
MM1540255	Xlok PP 50 mm	300 x 100 x 50	2.2
MM1529291	Xlok PP 25 mm	300 x 300 x 25	4.8
MM1529300	Xlok PP 25 mm	300 x 150 x 25	2.3
MM1540238	Xlok PP 25 mm	300 x 100 x 25	1.4

*Each liner assembly includes the liner and the fastener components. The backing plate is supplied separately.



Xlok fastener assembly standard parts

Part no.	Description	Dimensions	Mass (kg)
ZX11746079	M20 Threaded Insert	M20 x 12	0.13
ZX11709169	M20 Cap Screw	M20 x 30	0.11
ZX11757134	M16 Threaded Insert	M16 x 12	0.14
ZX11757133	M16 Cap Screw	M16 x 30	0.06
ZX11820961	Xlok Plug – 100 mm Liner	M45 x 70	0.10
ZX11709383	Xlok Plug – 50 mm Liner	M45 x 34	0.05
ZX11713445	Xlok Plug – 45 mm Liner	M45 x 29	0.05
ZX11767474	Xlok Plug – 25 mm Liner	M45 x 9	0.01

*Xlok fastener assembly components are supplied with each new liner. Individual items can also be supplied as per the above part number details



Xlok backing plate standard parts

Part no.	Description	Dimensions (WxLxT) mm	Mass (kg)
ZX11712902	Xlok backing plate	303 x 303 x 16	7.23
ZX11713184	Xlok backing plate	153 x 303 x 16	3.38
ZX11709176	Xlok backing plate	103 x 303 x 16	1.99

*The above part numbers represent the basic backing plate items. Customized backing plate arrays can also be supplied to suit individual application requirements

TaperLock

The TaperLock bolt replaces studs and enables a reduction in bolt intensity by up to 50% and the use of the SafeFit liner handling system. Fitted with RemLock, it also eliminates hot works and reduces nut removal time by up to 80%.

- Designed as a direct stud replacement
- Can be used with any non-ceramic wear liner
- High-strength grade 12.9 bolt system enables up to 50% fewer bolts, reducing change-out downtime
- Safer removal with no hot works and the use of the SafeFit system
- Nut removal time reduced by up to 80% (using RemLock)



Application areas

TaperLock can be used in any fixed plant assets, but is ideally suited to areas where studs are currently used and reducing the number of fasteners and change-out downtime is desirable. Installation examples include coarse ore stockpile hoppers, train loadout chutes and the spill face on bucket wheel reclaimers.

Materials

TaperLock is suitable for use with any metallic, weld overlay or polymer wear liner and has been successfully installed in Q&T plate, weld overlay, cast metal and polymer liners. The ability to create the hole when the liners are being cut makes Taper-T well suited to liners that are manufactured from a processed plate, such as Xalloy. The proprietary process used to make the tapered hole removes the need for the additional processing that would be required if studded connections were used.

Technical description

The TaperLock fastener consists of a hardened head with an integral high-strength bolt. The head is designed to completely fill the tapered hole in the liner minimizing preferential wear and incorporating a hexagonal recess to facilitate installation. For selected sizes, the hole in the liner is compatible with the SafeFit handling system, enabling larger liners to be safely lifted. Although TaperLock can be used with any type of nut, RemLock is recommended as it enables easy removal without the need for hot works.

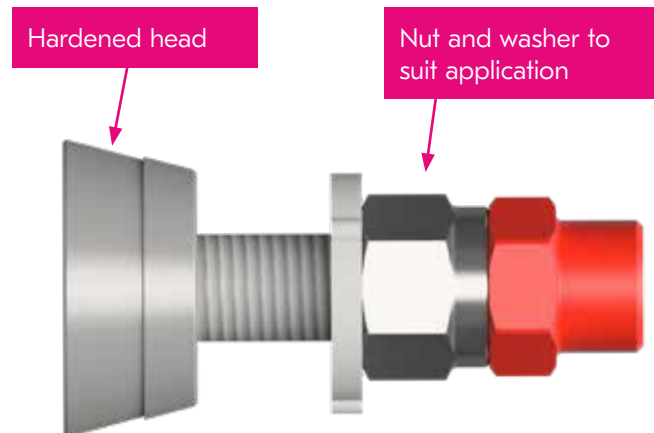

Naming convention

The TaperLock fastener can be designed for a wide variety of liner and wall thicknesses.

The naming convention is as follows:

TL X/MØ/Z

Where:

TL = TaperLock

X = Liner thickness

MØ = Bolt diameter

Z = Thread length

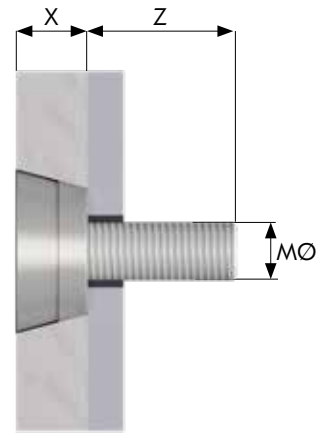

Installation and removal

There are no specialized tools required for the installation and removal of the TaperLock.

An Allen key is used to prevent the head from rotating during installation and a standard impact socket can be used to tighten the nut. A deep impact socket is required if RemLock is being used.

SafeFit tooling

For a selected range of TaperLock sizes, the hole in the liner is compatible with the SafeFit handling system, enabling you to safely lift larger liners. Please contact Metso Outotec to confirm whether the SafeFit system can be used in your application.

Option for wear monitoring

TaperLock fasteners can also be customized to enable the installation of wear sensors that will continually monitor the remaining thickness of the liner. Please contact Metso Outotec for additional information.

D-Lock

Designed as a replacement for studs, D-Lock is a high-strength bolting system that is compatible with the Metso Outotec SafeFit liner handling system. This facilitates a shift to larger liners with fewer fasteners, substantially reducing installation and removal times.



- Designed as a direct stud replacement for metallic liners
- Hole can be made when processing the liner plate
- High-strength bolt system enables up to 50% fewer bolts, reducing change-out downtime
- Compatible with SafeFit, enabling larger/fewer liners
- Nut removal time reduced by up to 80% when combined with RemLock)

Application areas

D-Lock can be used in any fixed plant assets, but is ideally suited to areas where studs are currently used and reducing the number of fasteners and change-out downtime is desirable. Installation examples include coarse ore stockpile hoppers, train loadout chutes and the spill face on bucket wheel reclaimers.

Materials

D-Lock can be used with any metallic material including Q&T plate, weld overlay and cast liners. The ability to create the when the liners are being cut makes D-Lock particularly suitable for liners that are manufactured from a processed plate, such as Xalloy.

Technical description

D-Lock features a unique head shape to prevent the bolt from rotating during installation and removal while still enabling the liner to be easily processed using standard plate cutting techniques. The head is designed to completely fill the hole in the liner when installed, to minimize preferential wear, and is hardened to match the liner properties.

D-Lock is supplied with an integral high-strength bolt and can be used with any type of nut, although Metso Outotec recommends using RemLock, as it protects the thread and minimizes the risk of having to resort to hot works when removing the liner.

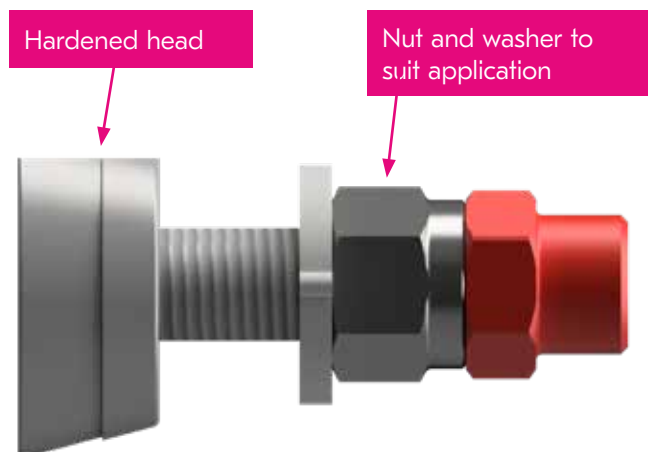

Naming convention

The D-Lock fastener can be designed for a wide variety of liner and wall thicknesses.

The naming convention is as follows:

DL X/MØ/Z

Where:

DL = D-Lock

X = Liner thickness

MØ = Bolt diameter

Z = Thread length

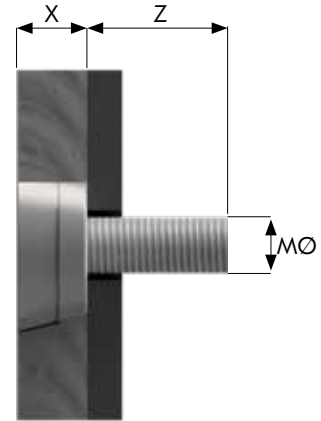

Installation and removal

There are no specialised tools required for the installation and removal of the TaperLock, however a deep impact socket is required if a Remlock is being used.

Option for wear monitoring

D-Lock fasteners can also be supplied with integrated wear sensors that will continually monitor the remaining thickness of the liner (refer to the wear monitoring section for further information).

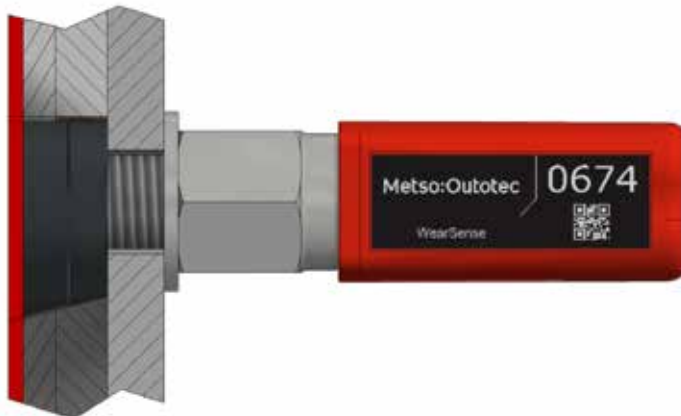

RemLock™

RemLock is an innovative locknut specifically created with the removal process in mind. The patented design eliminates the need for hot works, making the removal of nuts faster and safer.



- A unique locknut that replaces traditional nuts
- Fits all existing studs and standard bolts
- Simple, one-piece installation using a deep impact socket
- Separately removable nylon cover provides thread locking while also facilitating nut removal
- Nylon cover fully encapsulates the exposed bolt thread to minimize corrosion
- Effectively eliminates the need for hot works

Application areas

Can be used in all applications where a standard nut or locknut would normally be used. Particularly effective in applications where the nut may need to be loosened often for adjustment, such as skirt liners, as RemLock retains its locking properties even after multiple removals and re-installations. Ideal for use with TaperLock or D-Lock attachments to enhance the benefits that these systems provide.

Technical description

RemLock is a prevailing torque (lock) nut that combines thread locking with thread protection. It features a fully enclosed nylon cap that is mechanically attached to a high-strength metal nut. Although consisting of two parts, RemLock is supplied and installed as a single piece unit. RemLock conforms with the mechanical requirements of a Class 12 nut and exceeds the prevailing torque requirements of ISO 2320:2015.

RemLock is available to suit the most commonly used metric thread sizes and can also be custom-made to suit any metric or imperial thread size. Standard RemLock sizes are listed in the table below; for other sizes, please contact Metso Outotec.



Installation and removal tools for Taper-T fasteners

Part No.	Description	Thread MØ	Across flats AF	Nut height H1	Cap height H2	Usable depth D
ZX11861503	DWPS-RL-16	M16X2.0	24	19	23	40
ZX11861507	DWPS-RL-20	M20X2.5	30	24	28	50
ZX11861511	DWPS-RL-22	M22X2.5	34	26	26	50

Additional information

When using RemLocks, the thread length of the bolt or stud should be specified so that it lies between the recommended minimum and maximum values listed below:

$$Z_{min} = Y + T + H1 + 5mm$$

$$Z_{max} = Y + T + D$$

Where:

Z_{min} = the recommended minimum thread length

Z_{max} = the maximum allowable thread length

Y = the chute wall thickness (or overall joint thickness for a standard bolted connection)

T = the washer thickness

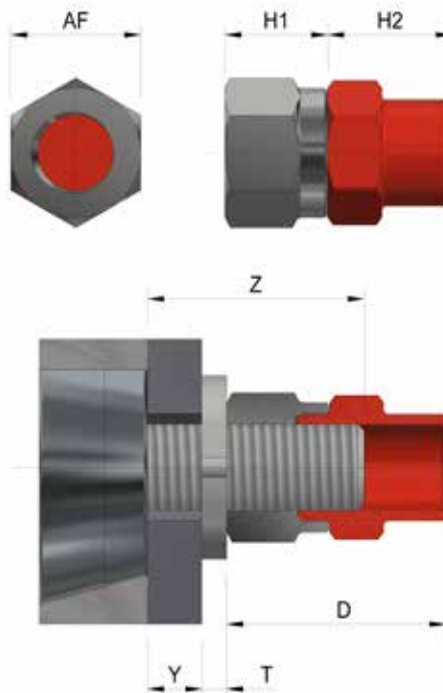

Installation and removal

RemLocks must be installed using a deep impact socket that encapsulates both the metal and nylon components. Ensure that the socket is fully seated on the metal nut when tightening RemLock.

A deep series socket is also used for removing RemLock. If the bolt is held securely, RemLock can be removed in one piece. However, it is also possible to first remove the nylon component of RemLock, leaving a clean thread and making the metal nut easier to remove. This method can be particularly effective if there is a risk of the bolt turning.



Scan the QR code or click here to visit the Metso Outotec website to see the Remlock demonstration video.



Handling systems

Handling systems

Improve worker safety by eliminating manual handling while at the same time facilitating quicker and easier replacement of the wear liner.

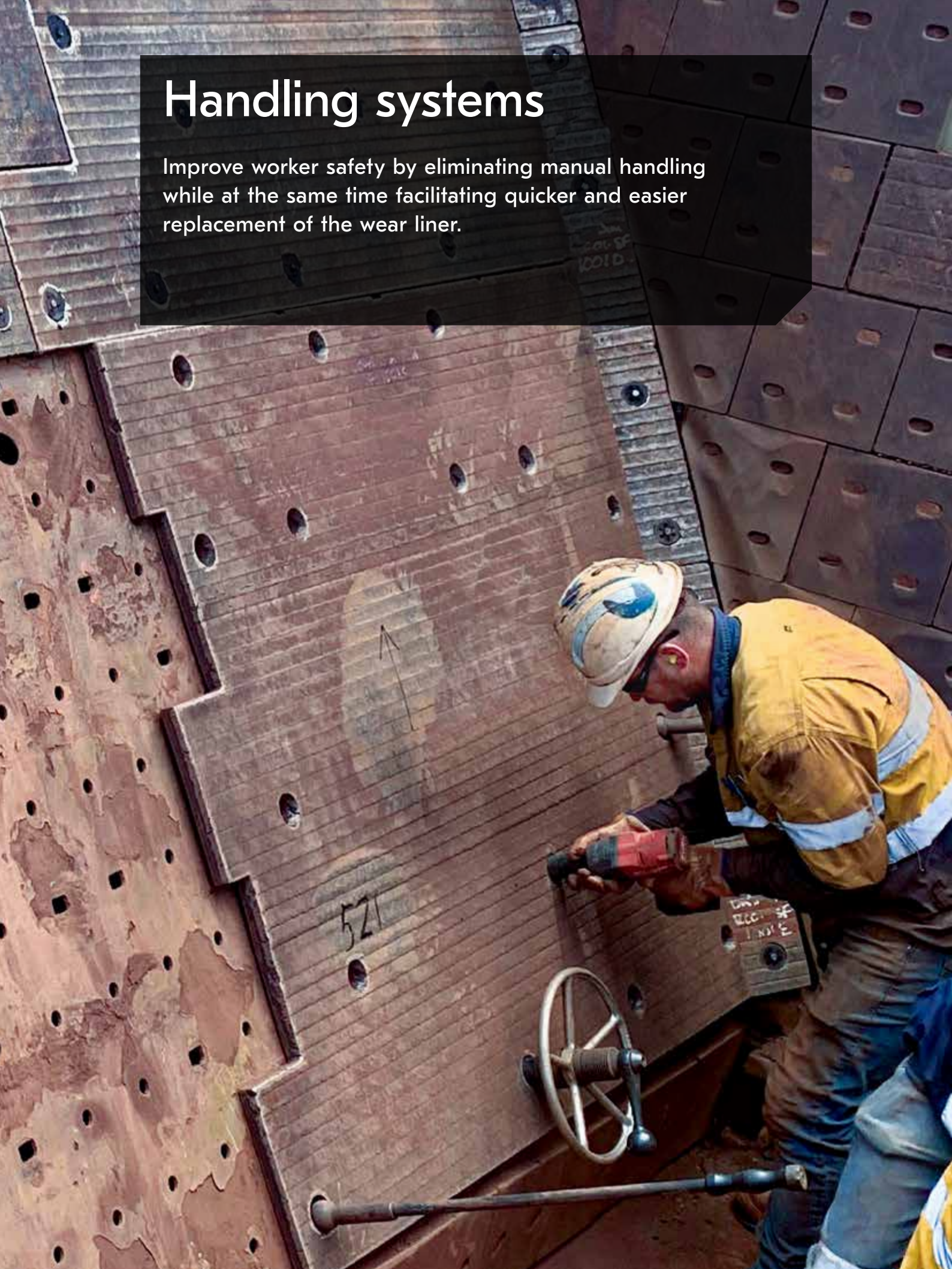

SafeFit™ handling system



SafeFit is a complete handling system designed to simplify the process of installing and removing wear liners. The system has been successfully used to install liners from ropes on a vertical wall without the need to manually handle the liners.

- Compatible with liners that incorporate the Metso Outotec patented tapered hole
- Safely lift liners of up to 1,000 kg
- Temporarily secures the liners to the chute wall while fasteners are being installed
- Easily adjust the liner position against the chute wall to align holes
- Works with new and worn liners, so can be used for installation and removal
- Enables the use of larger liners which can significantly reduce the change-out time
- Increases safety by ensuring the liner is always secured during the installation and removal process

Technical description

The SafeFit system consists of a range of tools specifically designed to facilitate the process of installing and removing liners.



Lifting clips

The SafeFit lifting clips are compatible with all liners that use the EzyLock, Taper-T or D-Lock attachment systems, and for liners that use larger TaperLock attachments. The clips fit through the same hole in the liner that is designed for the attachment and are securely locked in place by the lifting shackle. Each lifting clip has a WLL of 1,000 kg, which allows even the heaviest liners to be safely lifted.



SafeFit clamps holding a liner in position awaiting the installation of Taper-T attachments.

Clamping tools

There are currently two types of clamping tools available, which are designed to work with the EzyLock and Taper-T attachment systems. The clamps pass through the liner and lock into the Taper-T slot or EzyLock hole in the chute wall. The hand wheel located on each of the clamps can then be screwed in to pull the liner against the wall. Once the liner is held against the chute wall by the clamping tool, the lifting clips can be removed and attachments inserted to secure the liner.



Podgy bars

SafeFit podgy bars are available for the EzyLock and Taper-T attachment systems. The tip of the podgy bar fits into the Taper-T slot or EzyLock hole in the chute wall while the ball rests inside the tapered hole in the liner. The leverage provided by the bar allows the liners to be safely moved to accurately align the holes in the liner and chute wall. The podgy bar can be initially used to enable a clamping tool to be fitted and later used to adjust the liner position so that the fasteners can be installed.

SafeFit tools

Part no.	Description	Included components
ZX11861515	DWPS-SC1000-40	SafeFit scissor clip lifting device (1,000 kg WLL) to suit 40 mm tapered hole
ZX11861461	DWPS-POD-EL	SafeFit podgy bar to suit EzyLock attachment system
ZX11860939	DWPS-CT-EL	SafeFit clamping tool to suit EzyLock attachment system
ZX11861473	DWPS-POD-TT	SafeFit podgy bar to suit Taper-T attachment system
ZX11860950	DWPS-CT-TT	SafeFit clamping tool to suit Taper-T attachment system



Scissor clip



EzyLock podgy bar



EzyLock clamping tool



Taper-T podgy bar



Taper-T clamping tool



Scan the QR code or click here to visit the Metso Outotec website to see a video of the SafeFit handling system in use.



CRANE 2
WLL 5,000KG PER HOIST



Liftox™ lifting tool

The Liftox liner lifting tool has been designed by Metso Outotec to safely and efficiently lift Metso Outotec wear liner parts that incorporate the Liftox liner bolt hole design. The Liftox tool has a working load limit (WLL) of 500 kg and provides a secure connection between the wear liner and the crane, hoist, or winch. The Liftox tool eliminates manual handling of wear liners and provides the ability to reduce shutdown periods and downtime.



Technical description

Liftox lifting tool		
Part no.	Description	Mass (kg)
ZX11713058	Liftox liner lifting tool	3.7 kg

Xlok Liftx™ lifting tool

The Xlok Liftx liner lifting tool has been designed by Metso Outotec to safely and efficiently lift Xlok liner parts. The Xlok Liftx liner lifting tool has a working load limit (WLL) of 100 kg and provides a secure connection between the wear liner and the crane, hoist or winch. The Xlok Liftx tool eliminates manual handling of Xlok liners and provides the ability to reduce shutdown periods and downtime.

Technical description

Xlok Liftx lifting tool		
Part no.	Description	Mass (kg)
ZX11810434	Xlok Liftx lifting tool	6.94 kg



Wear monitoring systems

A car signals when it's time for a service
— why shouldn't your equipment do the same?



WearSense™

A self-contained wear monitoring solution for use with metallic or ceramic liners

- Monitor the liner wear in your critical chutes
- Can be used with most metallic and ceramic liners
- Estimate when to change your liners
- Reduce downtime and material wastage
- Continuous, real-time information on remaining thickness

WearSense is a wear management system consisting of proprietary IoT sensors that monitor wear and other key parameters in chute liners. Information from the sensors is relayed, via a gateway, to the cloud where it is analyzed and displayed through a secure web-based app. The user interface not only provides real time information on the current wear liner thickness but also estimates of the predicted end of life, enabling more informed decisions about liner maintenance.

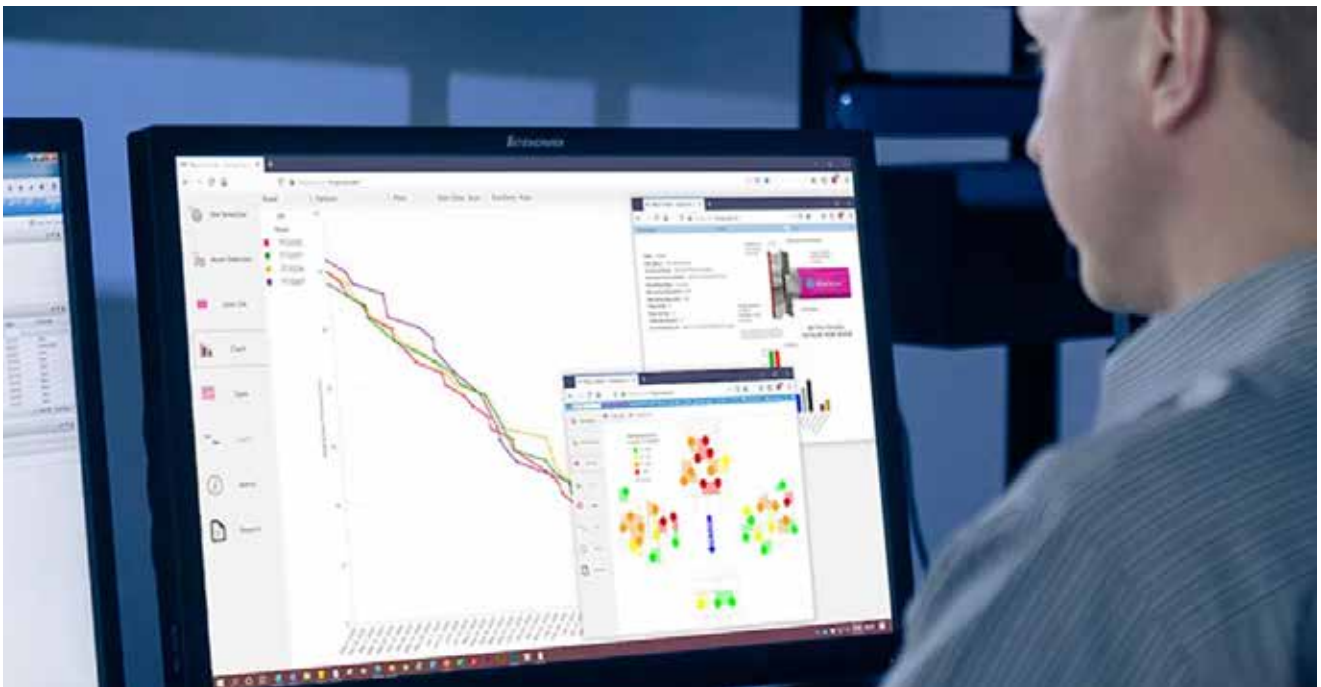

Application areas

WearSense can be used in any fixed plant assets, but is ideally suited to critical chutes where downtime can significantly impact on production or chutes that are hard to access for manual inspection. Installation examples include coarse ore stockpile hoppers, train loadout chutes and the spill face on bucket wheel reclaimers.

Materials

WearSense is suitable for most metallic and ceramic liners; the only requirement is that it must be possible to make a hole in the liner in order to install the wear sensor probe. Wear sensors have been successfully installed in Q&T plate, weld overlay, cast metal and ceramic liners.

Technical description

The WearSense system consists of three main components, the wear sensors, the receiver/gateway, and a web-based user interface. Standard wear sensors can measure liner thickness up to 140 mm; longer probe lengths are available on request. Sensors are capable of measuring with a resolution of 0.5 mm, 1 mm, or 2 mm, depending on the overall thickness of the liner being monitored, and can be supplied in either the Taper-T or Hugger form factor to best suit the application. Flexible receiver/gateway options are available, and full access to the asset wear data is provided to an unlimited number of users as part of the WearSense package.

Sensors

WearSense wireless wear sensors are simple to install and fully self-contained; they have a battery life of up to 5 years. They can be used with any ceramic or metallic liners and multiple installation options are available. The sensors have a glass-filled nylon housing for durability and are available in two different form factors:



The Hugger™

The Hugger sensor has a low profile to minimize surface projection and is recommended for applications where the liner may be subject to impact (such as deflector plates on head chutes).

Taper-T™

The Taper-T sensor has minimal cross section area that enables it to be easily inserted through holes. It works directly with Taper-T attachments or can be used as a “stand alone” sensor.

Receiver and gateway

The receiver communicates wirelessly with the sensors, which can be located up to 300 meters away. Each receiver can support up to 100 sensors. The gateway collects the information from the receiver and sends it to the cloud. Multiple receiver units can be connected to a single gateway. A range of receiver and gateway options are available, including a portable unit that requires no site installation, a temporary unit for trials and a cabinet for permanent installations.



Interface

The easy-to-use interface gives you access to all the data you need about your liner's wear performance. It also notifies you of potential issues and helps you predict when the liners need to be replaced.



The interface is accessible through a web app, which makes it available from any computer or smart device with an internet connection. Features of the interface include:

- Indication of remaining liner thickness at each sensor location
- Ability to set email alerts based on wear levels
- Time series chart of liner thickness with end of life prediction
- Sensor diagnostics, including battery life estimate
- Ability to export wear data as a CSV file for additional analysis

Data from the WearSense system can be integrated directly into other data management systems, such as a DCS panel, SAP or Data Historians, through an API.

Sensor installation

The system can be used with any liners, irrespective of the manufacturer or liner attachment method being used. When combined with the Taper-T one-sided liner fastening system, wear sensors can be installed without the need for any modifications to the liners or the chute. For other applications, the liner needs to be modified to accept an insert into which the wear sensor can be installed. The chute wall also requires an opening through which the sensor can pass. The slim design of the Taper-T wear sensor means that only a small diameter hole is required in the chute wall to facilitate the housing.

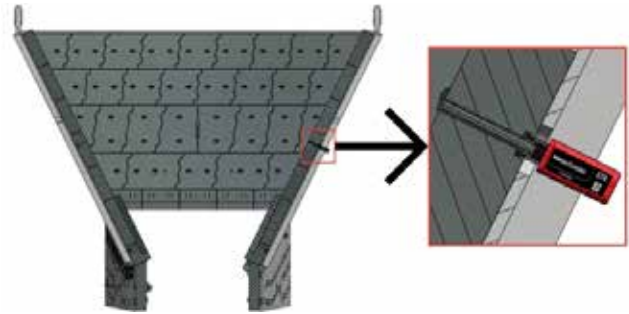

Custom design

Metso Outotec can also design custom adaptors that allow wear sensors to be integrated into almost any type of liner attachment system. This enables a wear monitoring system to be quickly installed without requiring any modification to the chute or liner.



Wear sensor integrated into an M20 bolt used to installed Q&T liners in a feed hopper.



Wear sensor integrated into an M30 TaperLock used to installed cast liners in a coarse ore stockpile hopper.



Scan the QR code or [click here](#) to learn how WearSense can help reduce the cost of maintaining your wear surfaces.

Value added services

Value added services

Metso Outotec is a one-stop supplier; not only do we provide high-quality wear parts, we also offer full solutions to address your specific needs using our in-house design, engineering, and simulation teams.

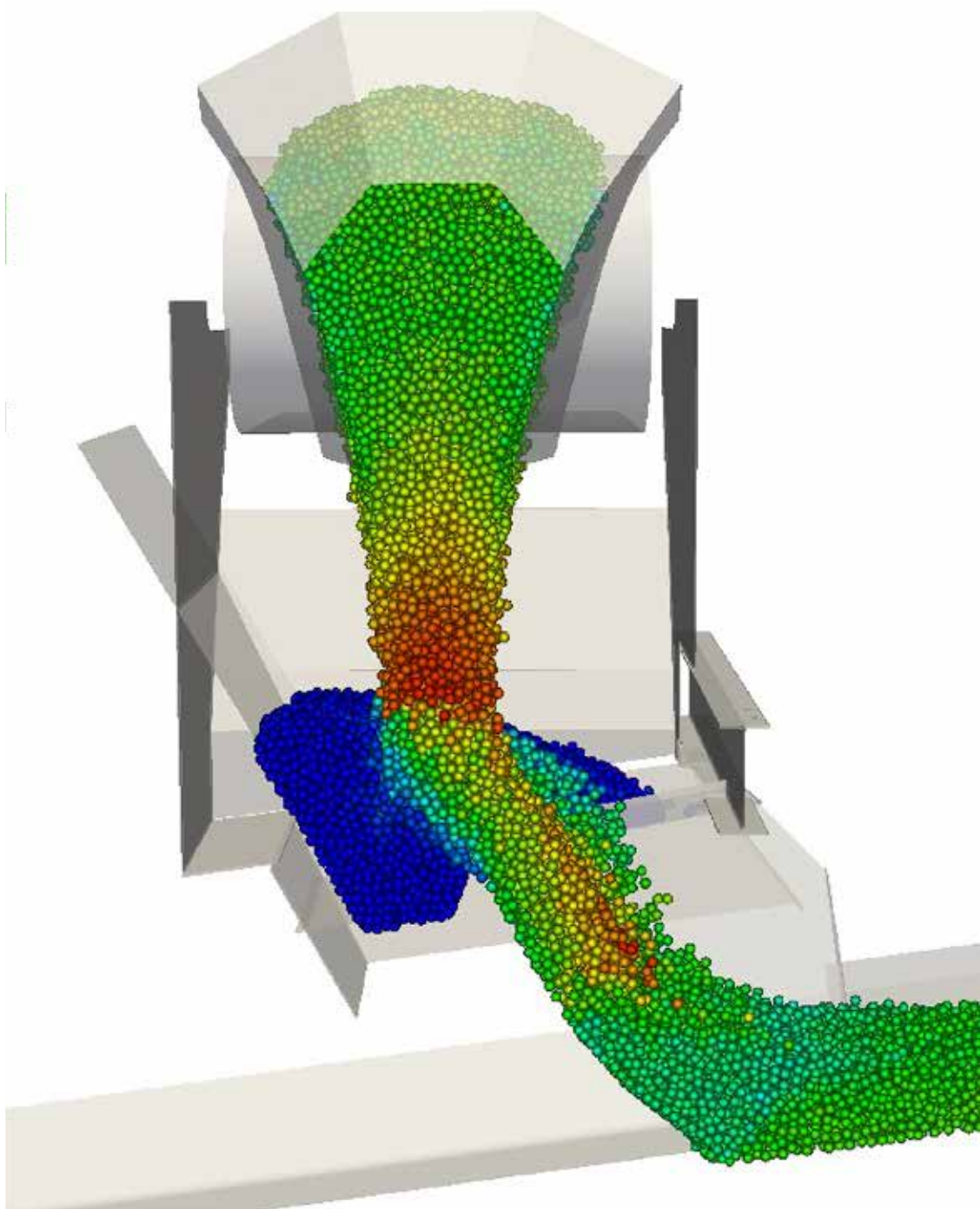

DEM Simulation

Discrete element modeling (DEM) provides a way to create a dynamic simulation of the real-world asset and provides accurate results that can be used with confidence to validate new designs and check the performance of proposed modifications. Using DEM, we are able to optimize the asset so that wear is minimized and better distributed, and flow is optimized to ensure reliable operation. In very special cases, physical modeling also allows for further testing and validation to ensure all solutions perform to the best possible standard. In combination with our team's vast experience, these simulations and modeling make it possible for us to provide the solution that is right for your application.

Application audit and product recommendation

Our experienced product application specialists can visit customer sites and perform detailed audits of chute assets to fully understand each customer's unique situation and challenges. Following a detailed analysis and an in-depth technical review process, we are able to suggest the best suited material selections that will meet the required wear life with the best possible cost benefit.



Concept and design development

Metso Outotec works with the customer through consultation, meetings and site visits to develop full chute solutions that deliver results. Our product application specialists manage this process with the experienced in-house design teams from the initial concept stage all the way to the full implementation of a new design solution. Our Technical Sales Support Team works with the customer during this process and beyond, working on continuous improvement as customer requirements evolve over time.



Metso:Outotec

INPMAR

95

56
MBC

Application examples

Crusher discharge vault

Xlok™ – Single-sided wear protection system

Challenge

Traditional crusher discharge chutes, vaults and octagonals are a challenge to protect with wear liners and can be even more difficult to maintain and repair. They are often surrounded by structural concrete, which prevents access to the back side of the chute and excludes the use of traditional fasteners.



Solution

For crusher discharge vaults, the Metso Outotec Xlok system is our preferred solution. It is a tough modular liner system designed to be accessed only from the inside of the chute. Xlok increases the wear performance of the area and reduces the maintenance work and relining time. Each individual liner can be easily handled and installed with replaceable fasteners for each new installation.



Results

These features will typically provide significant benefits over traditional vault liner systems.

- Xlok single-bolt liners are modular, quick to install and easy to remove
- Hot works in confined spaces to cut out or weld in liners can be eliminated
- The Xlok rockbox liner design provides significantly longer liner wear life over a flat liner, further reducing the number of shutdowns and overall maintenance required, making this an ideal solution to install in crusher vaults and other hard-to-access areas of the operation

Increased wear performance with better access and safety for chute linings.

Mill feed chute

Mill feed chute lining systems

Challenge

Unscheduled mill stops and breakdowns can create major issues for plant productivity. When the mill feed chute maintenance is not aligned with the mill and the chute becomes the bottleneck, overall plant performance will be impacted. Off-the-shelf or out-dated feed chute liner packages may not use optimal wear materials. Some traditional liner layout designs can promote chute wear and create poor presentation to the mill and accelerated wear of the mill liner.



Solution

Metso Outotec's upgraded liner package and improved liner and chute design can increase wear performance and reduce shutdown time. The innovative design allows for quick liner change-outs and maintenance. Liner joints with a Gridlock design eliminate joint wash. Liner profile will ensure wear material is located to provide optimal utilization to reduce wastage and extend wear life.

Results

- Innovative, customized liner packages improve safety and reduce labor during shutdowns
- Customized liners enable chute maintenance to be synchronized with scheduled mill shutdowns
- Improved production efficiencies
- Significantly reduced overall costs

Click or scan the QR code to read more on our website



Poor wear performance of 6 weeks was extended to 26+ weeks between shutdowns.

Stockpile hoppers

Gridlock liner packages for hoppers, bins, feeders and tub liners

Challenge

Large hoppers and bins can be difficult to maintain, and a stockpile hopper can make even inspections problematic when they are covered by a large stockpile. This can limit overall asset performance and leave most operations struggling to achieve maximum liner utilization.

Solution

A custom-designed Gridlock liner package from Metso Outotec reduces maintenance, extends operating life and improves wear performance of the equipment. A Gridlock system removes the weak points of a standard liner package where liner failure is most common, allowing for more production uptime.



Our patented Gridlock anti-wash joint profile is designed to disrupt the tracking of material along the joint lines and eliminates preferential wear at these locations. The Gridlock joint prevents vertical wash lines in bins and tubs and the horizontal wash lines commonly seen in feeder side-wall liners. Ribbed rockbox liners can also be incorporated into high wear zones and along edges to further protect these areas. Improved liner packages can be incorporated into removable/rotatable structures, for quick change-outs.

Result

Gridlock liner joints extend the wear life of your liners by eliminating one of the primary causes of premature liner failure. The innovative liner design protects high wear zones and extends the wear life in these areas, allowing for overall maximum utilization. Incorporating the use of rotatable/removable tubs and bins provides quick maintenance change-outs with improved safety, better access and an overall reduction in ongoing costs.

Metso Outotec innovative liner solutions tackle the biggest wear problems on site.

Impact plate

Rockbox impact plate wear liners



Challenge

It is often difficult to eliminate high-impact transfer points when dealing with transfer chutes or in loading stations. Wear liners can be in the direct line of fire and subject to significant impact wear and sliding abrasion. Wear hot-spots can often require constant patching and repairs. These assets can then become the main driver of maintenance shutdowns.

Solution

By incorporating Metso Outotec Rockbox liners into the equipment, this direct impact can be reduced and controlled. Rockbox liners are designed to provide increased liner wear life by reducing the surface area of the

liner exposed to wear. The raised blocks and ribs of the liners retain some of the product, promoting rock-on-rock wear to protect the liner and maximize liner life. Rockbox liners can be bolted into a chute to easily replace standard flat liners in harsh applications.

Result

A chute blowout is often the first sign that the wear liner has not lasted from shutdown to shutdown. Metso Outotec rockbox liners provide significant improvements and help extend wear life in high impact areas. Extended time between shutdowns and improved liner utilization all lead to reduced operating and maintenance costs.

Increases wear life by up to 20 weeks.

Hardrock transfer chute

Wearback™ transfer chute and Xledge™ liners



Challenge

Keeping transfer chute downtime to a minimum is one of the biggest challenges in the mining and aggregate industry. The material is tough on equipment, and liners need to be changed often.

Solution

What if the problem can instead be part of the solution? That's exactly how Xledge liners from Metso Outotec help. Our Wearback chutes are engineered and designed with a series of ledges that allow the transported material to build up throughout the chute. As a result, the material buries most of the Xledge liner, exposing only the top edge to wear. The curved internal Wearback chute profile controls the speed and material flow from top to bottom. Material is guided through transitions to align with the outgoing conveyor and soft load the material centered onto the receiving belt.

Result

A dramatic decrease in maintenance downtime - by up to 70%, in some cases. In addition, stockholding is easily managed, as an entire chute may use as few as only five different Xledge liner sizes.

Reduces downtime for maintenance
by up to 70%.

Hood and spoon transfer chute

Poly-Cer™ and Xalloy™ – low friction and exceptional wear performance



Challenge

A transfer chute using an upper hood and lower discharge spoon is a design that has been used for many years – and often with poor performance when it comes to availability and maintenance issues. When material is difficult to handle, a hood and spoon chute must promote a free flowing transfer from the feed conveyor to the receiving belt. Wear materials and chute design are critical and must work together to achieve the level of performance that we bring to our customers.

Solution

By focusing on the selection of superior wear material and validated custom designs, Metso Outotec is able to offer hood and spoon transfer chutes that will keep material moving through the chute and provide optimal wear performance, extending life while reducing downtime and maintenance.

Result

Metso Outotec wear products like Poly-Cer and Xalloy are ideal for providing a combination of low friction and exceptional wear performance for both sliding and impact protection.

The right combination of wear material
and chute design.

Bucket wheel reclaimer spill faces

Taper-T™ and Xalloy™ - single-sided attachment combined with exceptional wear resistance

Challenge

Bucket wheel reclaimers are critical assets in mining operations, where downtime can directly impact production. The liners on the spill face often present a maintenance challenge, as they consist of multiple small liners and each requires access from the confined space behind the sloping spill face wall.



Solution

By combining multiple small liners into fewer broad sheet liners and utilizing high-tensile Taper-T attachments, the number of liners and fasteners can be significantly reduced. Tapered holes in the liners facilitate the use of the SafeFit handling system, which enables the liners to be safely lifted using a crane and secured in position while the fasteners are installed. The combination of excellent impact and abrasion resistance provided by the Xalloy plate completes the solution.

Result

Metso Outotec addresses the challenges of bucket wheel reclaimer spill face maintenance through improvements in liner layout and by combining correct material selection with an innovative attachment system. Typical results from this approach include:

- Up to 90% fewer liners
- Fewer liners and fasteners minimizes liner change-out time
- Utilizing Taper-T attachments eliminates the need to access the confined space at the rear of the spill face
- Ability to use the SafeFit handling system reduces manual handling of liners
- Choosing an Xalloy material with a wear life that more closely matches the machine maintenance intervals improves sustainability

Improved safety and up to
80% reduction in downtime,

Coarse ore stockpile hoppers

WearSense – real-time wear monitoring system for chute liners

Challenge

Accurately predicting when to change liners in COS (coarse ore stockpile) feeder hoppers can be problematic. Running down the stockpile to take 3D scans is expensive and disruptive. External ultrasonic thickness testing of the liners may be possible but often gives false information if composite materials (such as weld overlay) are being used.



Solution

Using knowledge of historical wear profiles, or DEM simulations, wear sensors are installed at selected locations within the COS hopper. Sensors can be installed in existing liners or supplied as part of a new liner package. The WearSense system monitors the remaining liner thickness in real time while the equipment is operating and without having to empty the stockpile. Information from the WearSense system is displayed on a web app and provides the user with current liner thickness and the wear trend, which can be used to estimate the end of liner life.



Result

The WearSense system provides insight into the current condition of wear liners through the strategic placement of wear sensors that monitor remaining thickness. Some of the benefits provided by the installation of WearSense in COS hoppers include:

- Identification of accelerated wear that would not have been anticipated based on past liner performance
- Orders can be placed for items with long lead times, thanks to predictions for the end of liner life
- More effective maintenance planning
- Improved sustainability through better utilization of the liner material

Visibility into remaining wear life enables better shutdown planning.





